

# LM561B – 5630 Middle Power LED for High CRI



## Introduction

### Features

- Beam Angle: 120°
- Precondition : JEDEC Level 2a
- Dimension : 5.6 x 3.0 x 0.8 mm
- ESD withstand Voltage : up to  $\pm 5$ KV [HBM]

### Applications

- INDOOR LIGHTING : Ambient Light, LED tube, Down light, LED bulb and Ceiling Light

## SAMSUNG ELECTRONICS

95, Samsung2-Ro, Giheung-Gu,  
Yongin-City, Gyeonggi-Do 446-711, KOREA

## Contents

1. Product Code Information	-----	3
2. Characteristics	-----	8
3. Typical Characteristics Graph	-----	9
4. Outline Drawing & Dimension	-----	13
5. Reliability Test Items & Conditions	-----	14
6. Solder Conditions	-----	15
7. Tape & Reel	-----	16
8. Label Structure	-----	18
9. Packing Structure	-----	19
10. Precaution For Use	-----	22
11. Hazard Substance Analysis Report	-----	25
Revision History	-----	47

# 1. Product Code Information

## 1) Luminous Flux Bins ( $T_s = 25^\circ\text{C}$ )

Nominal CCT	Product Code	Flux Rank	Sorting Condition $I_m$ @65mA
			Flux Range ( $\Phi_v, I_m$ )
2700K	SPMWHT541MD7WAW☆S0	SY	20.0 ~ 22.0
		SZ	22.0 ~ 24.0
		S1	24.0 ~ 26.0
3000K	SPMWHT541MD7WAV☆S0	SY	20.5 ~ 22.5
		SZ	22.5 ~ 24.5
		S1	24.5 ~ 26.5
3500K	SPMWHT541MD7WAU☆S0	SY	22.0 ~ 24.0
		SZ	24.0 ~ 26.0
		S1	26.0 ~ 28.0
4000K	SPMWHT541MD7WAT☆S0	SY	23.0 ~ 25.0
		SZ	25.0 ~ 27.0
		S1	27.0 ~ 29.0

**Notes:**

- 1)SAMSUNG ELECTRONICS maintains a tolerance of  $\pm 5\%$  on Luminous Flux measurements.
- 2)Warm white : "☆" can be "0"(Whole Bin), "H"(Half Bin) or "M"(Quarter Bin) of the color binning.

## 2) Color Bins ( $T_s = 25^\circ\text{C}$ )

### 2-1) Color Binning

Nominal CCT	Product Code	Color Rank	Chromaticity Bins
2700K	SPMWHT541MD7WAW0S0	W0(Whole bin)	W1, W2, W3, W4, W5, W6, W7, W8, W9, WA, WB, WC, WD, WE, WF, WG
	SPMWHT541MD7WAWHS0	WH(Half bin)	W5, W6, W7, W8 W9, WA, WB, WC
	SPMWHT541MD7WAWMS0	WM(Quarter bin)	W6, W7, WA, WB
3000K	SPMWHT541MD7WAV0S0	V0(Whole bin)	V1, V2, V3, V4, V5, V6, V7, V8, V9, VA, VB, VC, VD, VE, VF, VG
	SPMWHT541MD7WAVHS0	VH(Half bin)	V5, V6, V7, V8 V9, VA, VB, VC
	SPMWHT541MD7WAVMS0	VM(Quarter bin)	V6, V7, VA, VB
3500K	SPMWHT541MD7WAV0S0	U0(Whole bin)	U1, U2, U3, U4, U5, U6, U7, U8, U9, UA, UB, UC, UD, UE, UF, UG
	SPMWHT541MD7WAVHS0	UH(Half bin)	U5, U6, U7, U8 U9, UA, UB, UC
	SPMWHT541MD7WAVMS0	UM(Quarter bin)	U6, U7, UA, UB
4000K	SPMWHT541MD7WAT0S0	T0(Whole bin)	T1, T2, T3, T4, T5, T6, T7, T8, T9, TA, TB, TC, TD, TE, TF, TG
	SPMWHT541MD7WATHS0	TH(Half bin)	T5, T6, T7, T8, T9, TA, TB, TC
	SPMWHT541MD7WATMS0	TM(Quarter bin)	T6, T7, TA, TB

2-2) Chromaticity Region & Coordinates

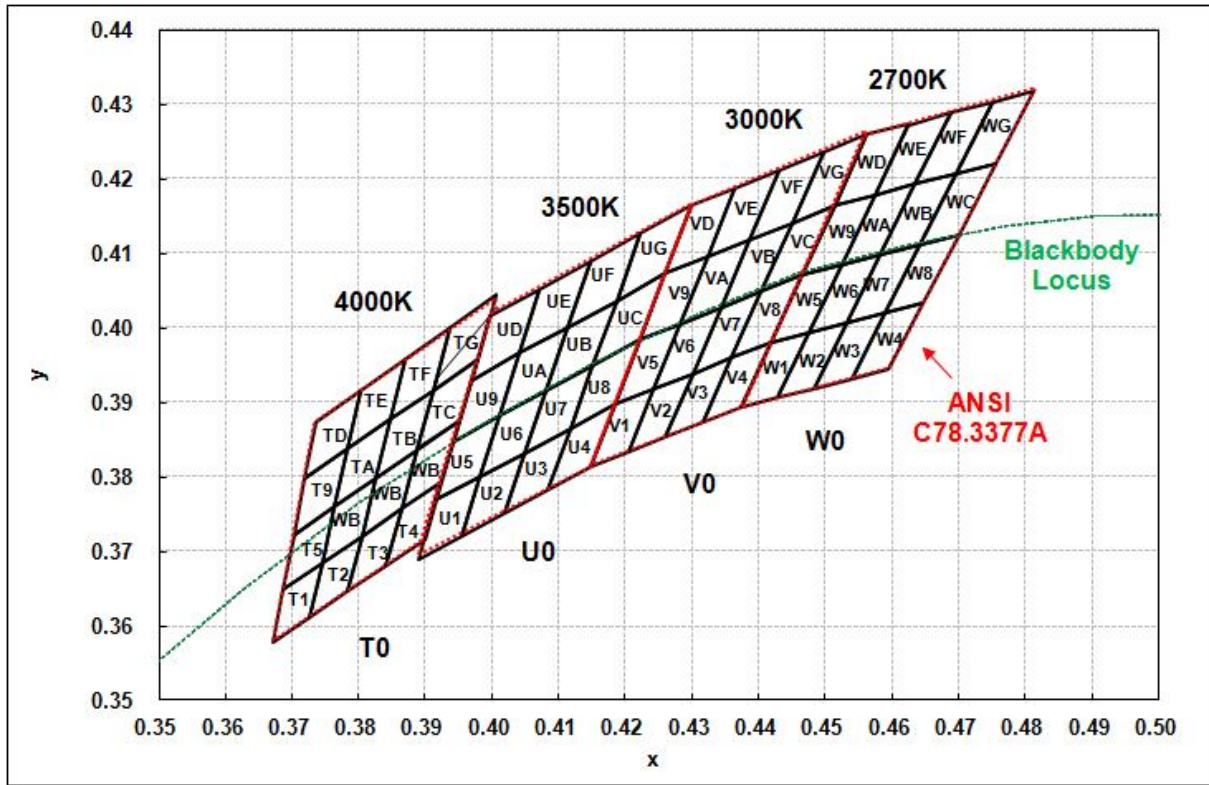



## 2-3) Chromaticity Region & Coordinates

Region	CIE X	CIE Y	Region	CIE X	CIE Y
W rank (2700K)					
W1	0.4373	0.3893	W9	0.4465	0.4071
	0.4418	0.3981		0.4513	0.4164
	0.4475	0.3994		0.4573	0.4178
	0.4428	0.3906		0.4523	0.4085
W2	0.4428	0.3906	WA	0.4523	0.4085
	0.4475	0.3994		0.4573	0.4178
	0.4532	0.4008		0.4634	0.4193
	0.4483	0.3919		0.4582	0.4099
W3	0.4483	0.3919	WB	0.4582	0.4099
	0.4532	0.4008		0.4634	0.4193
	0.4589	0.4021		0.4695	0.4207
	0.4538	0.3931		0.4641	0.4112
W4	0.4538	0.3931	WC	0.4641	0.4112
	0.4589	0.4021		0.4695	0.4207
	0.4646	0.4034		0.4756	0.4221
	0.4593	0.3944		0.4700	0.4126
W5	0.4418	0.3981	WD	0.4513	0.4164
	0.4465	0.4071		0.4562	0.4260
	0.4523	0.4085		0.4624	0.4274
	0.4475	0.3994		0.4573	0.4178
W6	0.4475	0.3994	WE	0.4573	0.4178
	0.4523	0.4085		0.4624	0.4274
	0.4582	0.4099		0.4687	0.4289
	0.4532	0.4008		0.4634	0.4193
W7	0.4532	0.4008	WF	0.4634	0.4193
	0.4582	0.4099		0.4687	0.4289
	0.4641	0.4112		0.4750	0.4304
	0.4589	0.4021		0.4695	0.4207
W8	0.4589	0.4021	WG	0.4695	0.4207
	0.4641	0.4112		0.4750	0.4304
	0.4700	0.4126		0.4813	0.4319
	0.4646	0.4034		0.4756	0.4221

Region	CIE X	CIE Y	Region	CIE X	CIE Y
V rank (3000K)					
V1	0.4147	0.3814	V9	0.4221	0.3984
	0.4183	0.3898		0.4259	0.4073
	0.4242	0.3919		0.4322	0.4096
	0.4203	0.3833		0.4281	0.4006
V2	0.4203	0.3833	VA	0.4281	0.4006
	0.4242	0.3919		0.4322	0.4096
	0.4300	0.3939		0.4385	0.4119
	0.4259	0.3853		0.4342	0.4028
V3	0.4259	0.3853	VB	0.4342	0.4028
	0.4300	0.3939		0.4385	0.4119
	0.4359	0.3960		0.4449	0.4141
	0.4316	0.3873		0.4403	0.4049
V4	0.4316	0.3873	VC	0.4403	0.4049
	0.4359	0.3960		0.4449	0.4141
	0.4418	0.3981		0.4513	0.4164
	0.4373	0.3893		0.4465	0.4071
V5	0.4183	0.3898	VD	0.4259	0.4073
	0.4221	0.3984		0.4299	0.4165
	0.4281	0.4006		0.4364	0.4188
	0.4242	0.3919		0.4322	0.4096
V6	0.4242	0.3919	VE	0.4322	0.4096
	0.4281	0.4006		0.4364	0.4188
	0.4342	0.4028		0.4430	0.4212
	0.4300	0.3939		0.4385	0.4119
V7	0.4300	0.3939	VF	0.4385	0.4119
	0.4342	0.4028		0.4430	0.4212
	0.4403	0.4049		0.4496	0.4236
	0.4359	0.3960		0.4449	0.4141
V8	0.4359	0.3960	VG	0.4449	0.4141
	0.4403	0.4049		0.4496	0.4236
	0.4465	0.4071		0.4562	0.4260
	0.4418	0.3981		0.4513	0.4164

## 2) Chromaticity Region & Coordinates (Continued)

Region	CIE X	CIE Y	Region	CIE X	CIE Y
U rank (3500K)					
U1	0.3889	0.3690	U9	0.3941	0.3848
	0.3915	0.3768		0.3968	0.3930
	0.3981	0.3800		0.4040	0.3966
	0.3953	0.3720		0.4010	0.3882
U2	0.3953	0.3720	UA	0.4010	0.3882
	0.3981	0.3800		0.4040	0.3966
	0.4048	0.3832		0.4113	0.4001
	0.4017	0.3751		0.4080	0.3916
U3	0.4017	0.3751	UB	0.4080	0.3916
	0.4048	0.3832		0.4113	0.4001
	0.4116	0.3865		0.4186	0.4037
	0.4082	0.3782		0.4150	0.3950
U4	0.4082	0.3782	UC	0.4150	0.3950
	0.4116	0.3865		0.4186	0.4037
	0.4183	0.3898		0.4259	0.4073
	0.4147	0.3814		0.4221	0.3984
U5	0.3915	0.3768	UD	0.3968	0.3930
	0.3941	0.3848		0.3996	0.4015
	0.4010	0.3882		0.4071	0.4052
	0.3981	0.3800		0.4040	0.3966
U6	0.3981	0.3800	UE	0.4040	0.3966
	0.4010	0.3882		0.4071	0.4052
	0.4080	0.3916		0.4146	0.4089
	0.4048	0.3832		0.4113	0.4001
U7	0.4048	0.3832	UF	0.4113	0.4001
	0.4080	0.3916		0.4146	0.4089
	0.4150	0.3950		0.4222	0.4127
	0.4116	0.3865		0.4186	0.4037
U8	0.4116	0.3865	UG	0.4186	0.4037
	0.4150	0.3950		0.4222	0.4127
	0.4221	0.3984		0.4299	0.4165
	0.4183	0.3898		0.4259	0.4073

Region	CIE X	CIE Y	Region	CIE X	CIE Y
T rank (4000K)					
T1	0.367	0.3578	T9	0.3702	0.3722
	0.3726	0.3612		0.3763	0.376
	0.3744	0.3685		0.3782	0.3837
	0.3686	0.3649		0.3719	0.3797
T2	0.3726	0.3612	TA	0.3763	0.3760
	0.3783	0.3646		0.3825	0.3798
	0.3804	0.3721		0.3847	0.3877
	0.3744	0.3685		0.3782	0.3837
T3	0.3783	0.3646	TB	0.3825	0.3798
	0.3840	0.3681		0.3887	0.3836
	0.3863	0.3758		0.3912	0.3917
	0.3804	0.3721		0.3847	0.3877
T4	0.384	0.3681	TC	0.3887	0.3837
	0.3898	0.3716		0.395	0.3875
	0.3924	0.3794		0.3978	0.3958
	0.3863	0.3758		0.3912	0.3917
T5	0.3686	0.3649	TD	0.3719	0.3797
	0.3744	0.3685		0.3782	0.3837
	0.3763	0.376		0.3802	0.3916
	0.3702	0.3722		0.3736	0.3874
T6	0.3744	0.3685	TE	0.3782	0.3837
	0.3804	0.3721		0.3847	0.3877
	0.3825	0.3798		0.3869	0.3958
	0.3763	0.376		0.3802	0.3916
T7	0.3804	0.3721	TF	0.3847	0.3877
	0.3863	0.3758		0.3912	0.3917
	0.3887	0.3836		0.3937	0.4001
	0.3825	0.3798		0.3869	0.3958
T8	0.3863	0.3758	TG	0.3912	0.3917
	0.3924	0.3794		0.3978	0.3958
	0.395	0.3875		0.4006	0.4044
	0.3887	0.3836		0.3937	0.4001

**Notes:** SAMSUNG ELECTRONICS maintains  $\pm 0.005$  tolerance of Cx, Cy

## 2. Characteristics

### 1) Absolute Maximum Rating

Item	Symbol	Rating	Condition
Operating temperature range	$T_{op}$	-40 °C ~ +85 °C	-
Storage temperature range	$T_{stg}$	-40 °C ~ +120 °C	-
LED junction temperature	$T_J$	110 °C	-
Forward Current	$I_F$	150 mA	-
Peak Pulsed Forward Current	$I_{FP}$	300 mA	Duty 1/10 pulse width 10ms
Thermal resistance	$R_{th, j-s}$	16 °C/W	Junction to solder point
Assembly Process Temperature	-	260 °C, < 10sec	-
ESD	-	5kV	HBM

### 2) Electro-optical Characteristics

Item	Unit	Nominal CCT	Product Code	Rank	Min	Typ	Max	
Forward Voltage ( $V_F$ ) (@65 mA, $T_s = 25^\circ\text{C}$ )	V	-	-	WA	AZ	2.70	-	2.80
					A1	2.80	-	2.90
					A2	2.90	-	3.00
					A3	3.00	-	3.10
					A4	3.10	-	3.20
Luminous Flux ( $\Phi_v$ ) (@65 mA, $T_s = 25^\circ\text{C}$ )	lm	2700K (W☆)	*WAW☆S0	SY	20.0	-	22.0	
				SZ	22.0	-	24.0	
				S1	24.0	-	26.0	
		3000K (V☆)	*WAV☆S0	SY	20.5	-	22.5	
				SZ	22.5	-	24.5	
				S1	24.5	-	26.5	
		3500K (U☆)	*WAU☆S0	SY	22.0	-	24.0	
				SZ	24.0	-	26.0	
				S1	26.0	-	28.0	
		4000K (T☆)	*WAT☆S0	SY	23.0	-	25.0	
				SZ	25.0	-	27.0	
				S1	27.0	-	29.0	
Reverse Voltage (@5 mA, $T_s = 25^\circ\text{C}$ )	V	-	-	-	0.7	-	1.2	
Color Rendering Index( $R_a$ )	-	-	-	7	90	-	-	
Special CRI (R9)	-	-	-	-	50	-	-	

#### Notes:

- 1) SAMSUNG ELECTRONICS maintains a tolerance of  $V_F:\pm 0.1$  V,  $\Phi_v:\pm 5$  %,  $R_a:\pm 3.0$ , R9  $:\pm 6.5$  on measurements
- 2) " \* " is Product Code of "SPMWH◆541MD7".



### 3. Typical Characteristics Graph ( $T_s = 25^\circ\text{C}$ )

#### 1) Spectrum Distribution

[CCT : 2700K & 3000K]

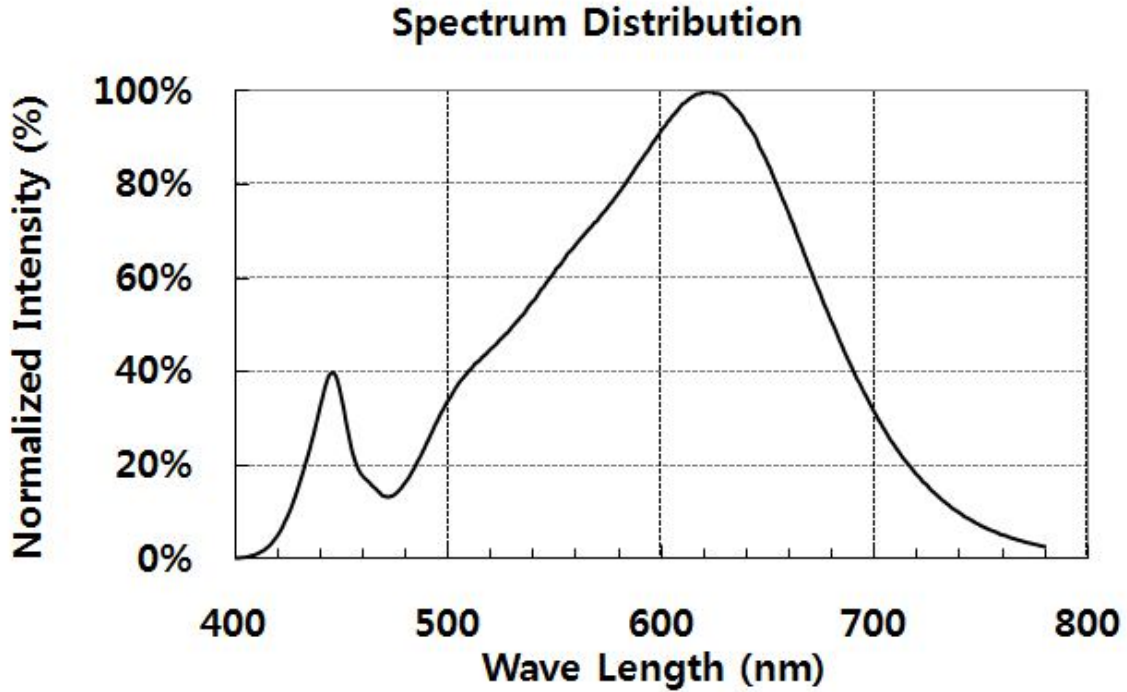

[CCT : 3500K & 4000K]

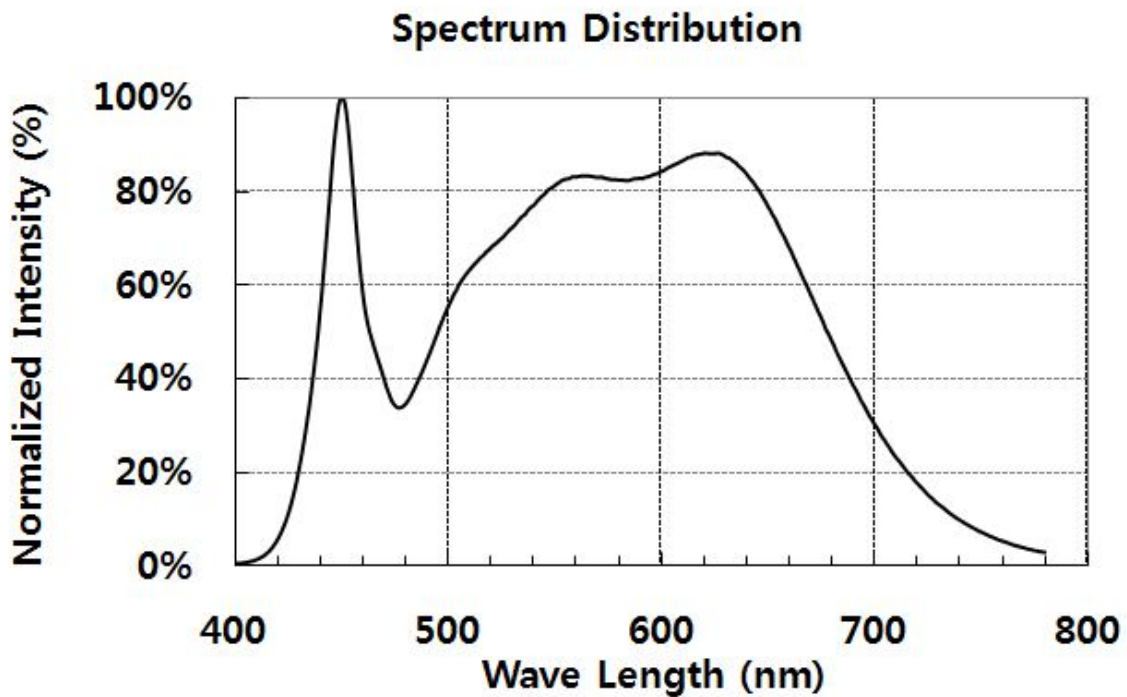

## 2) Forward Current Characteristics

[Relative Luminous Flux vs. Forward Current]

( $T_s = 25^\circ\text{C}$ )

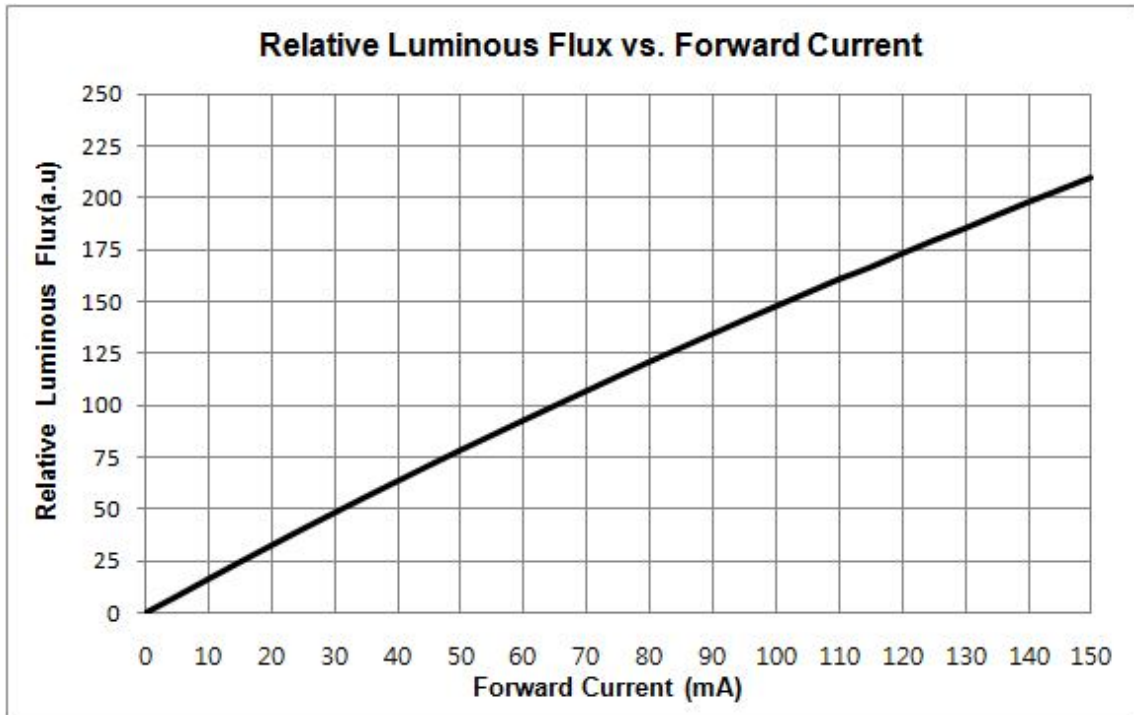

[Forward Current vs. Forward Voltage]

( $T_s = 25^\circ\text{C}$ )

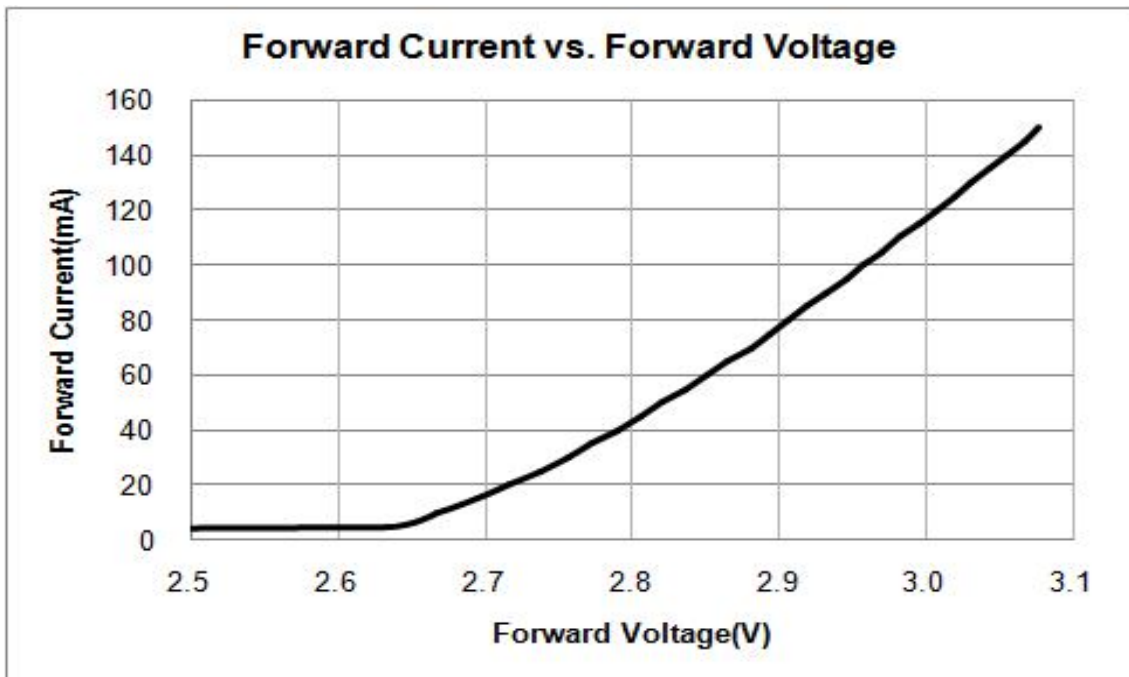

### 3) Temperature Characteristics

[Relative Luminous Flux vs.  $T_s$ ]

( $I_F = 65\text{mA}$ )

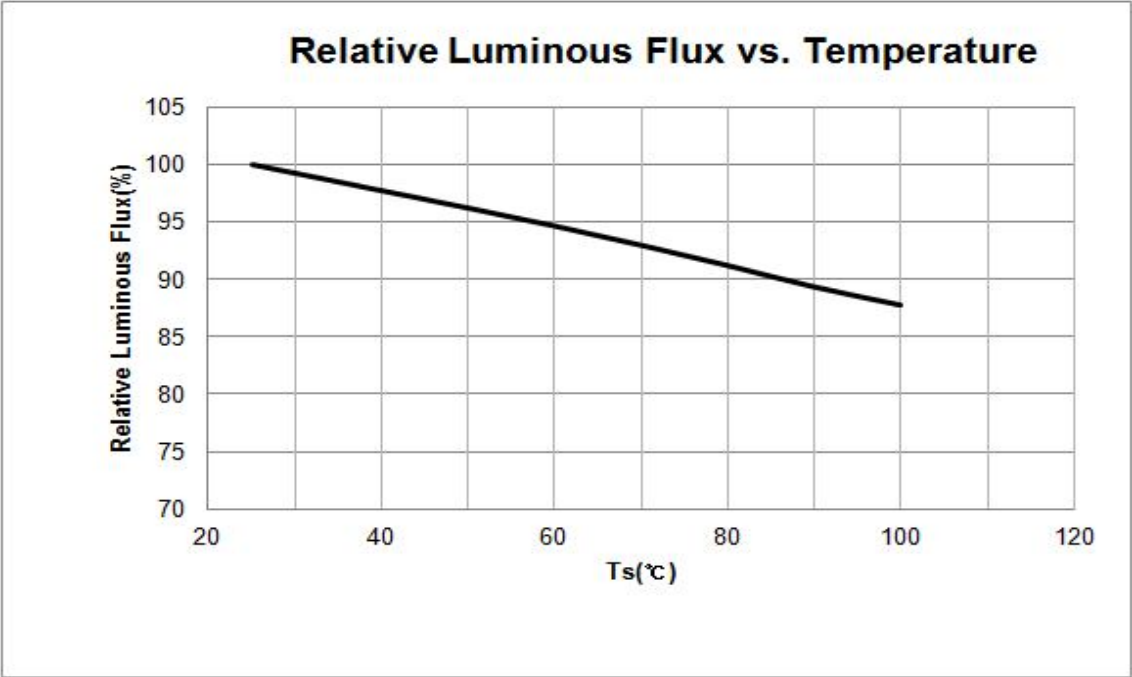

[Forward Voltage vs.  $T_s$ ]

( $I_F = 65\text{mA}$ )

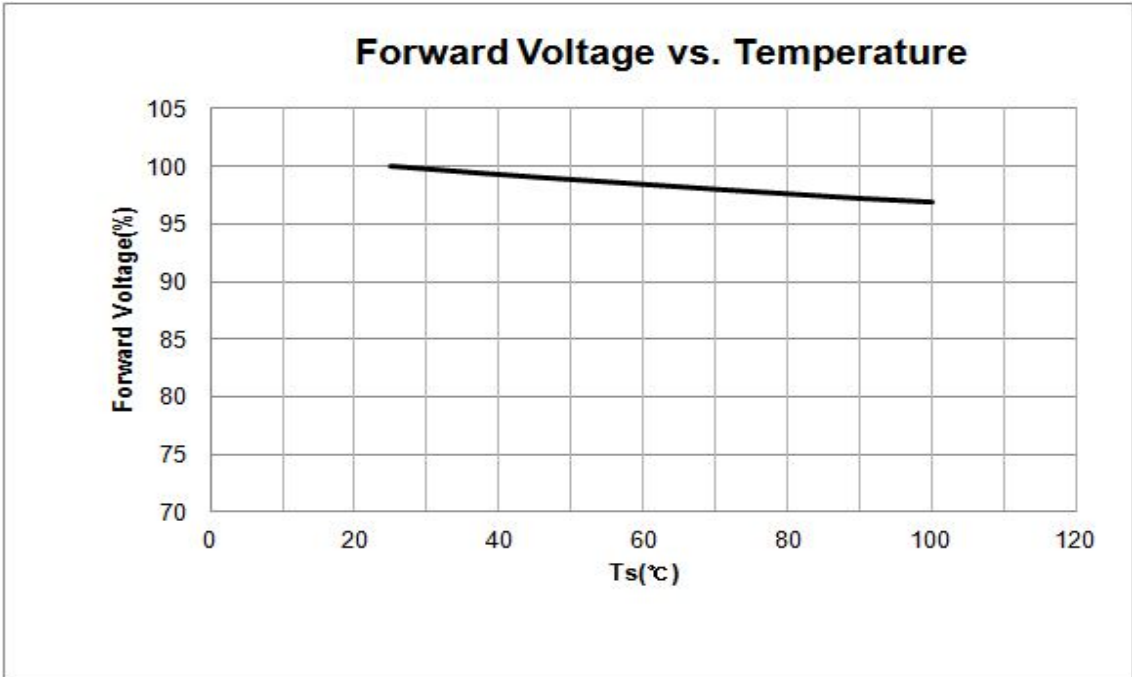

#### 4) Color shift Characteristics

[Color  $\Delta x$ ,  $\Delta y$  vs. Forward Current]

( $T_s = 25^\circ\text{C}$ )

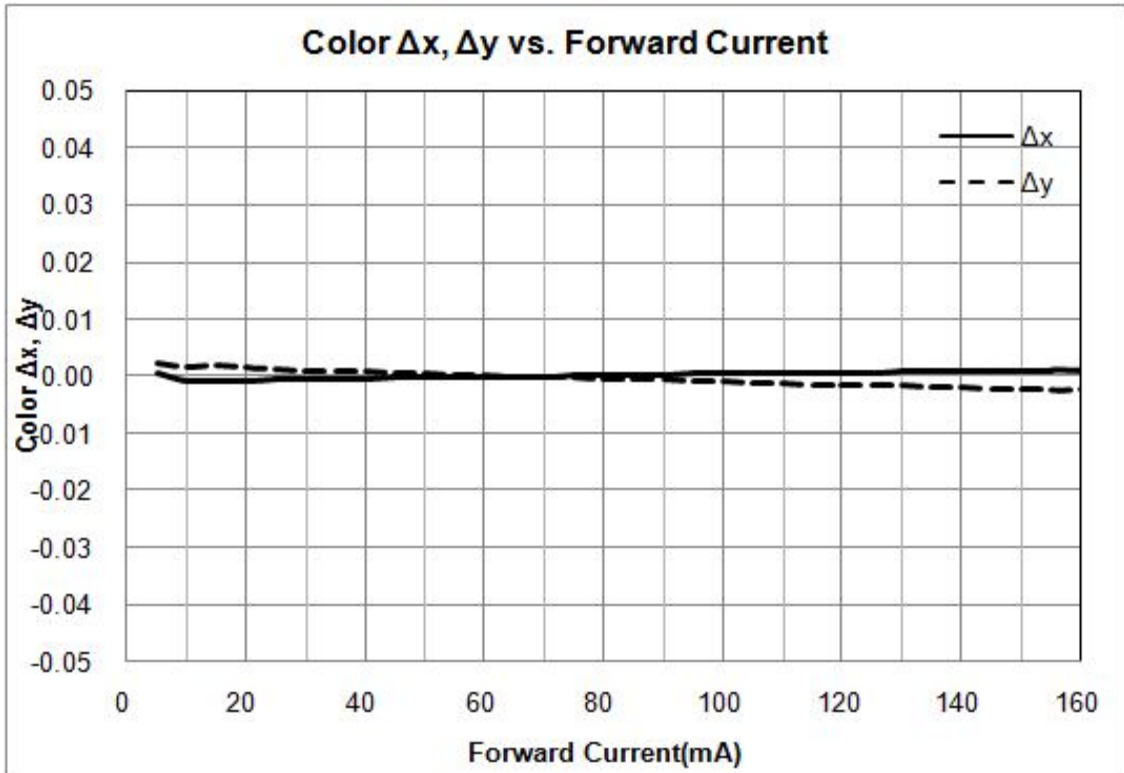

[Color  $\Delta x$ ,  $\Delta y$  vs.  $T_s$ ]

( $I_F = 65\text{mA}$ )

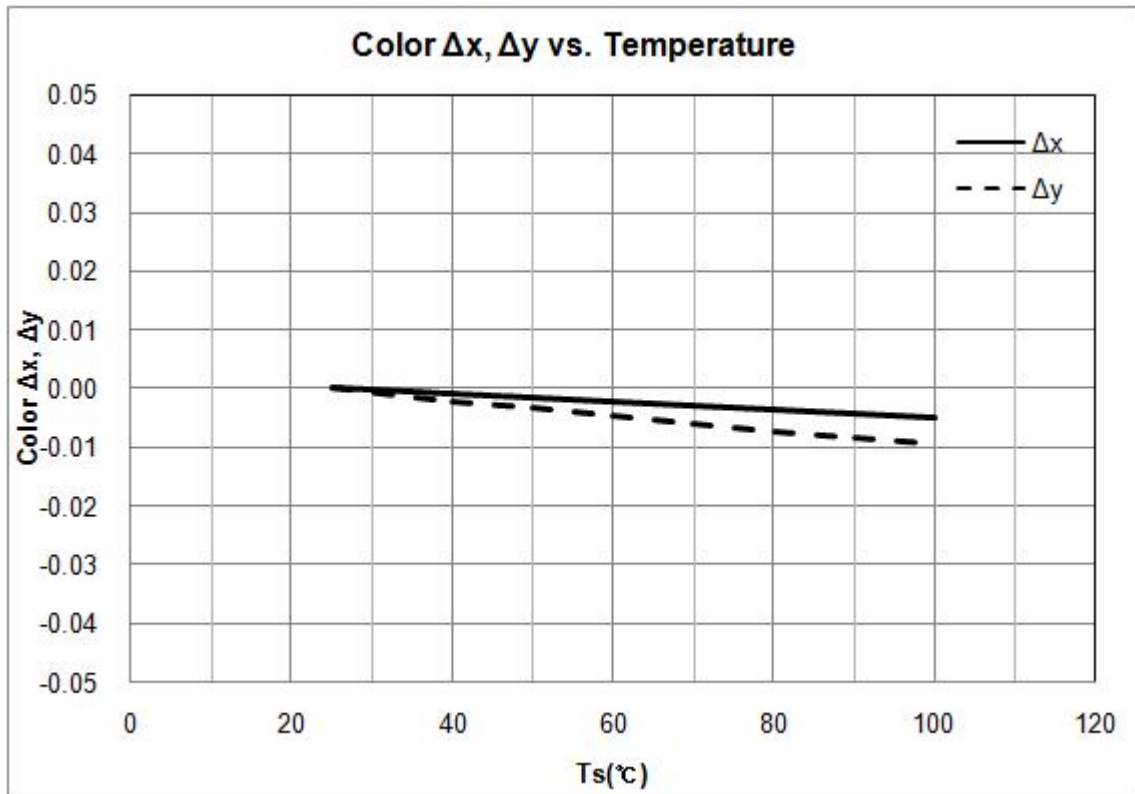

### 5) Derating Curve

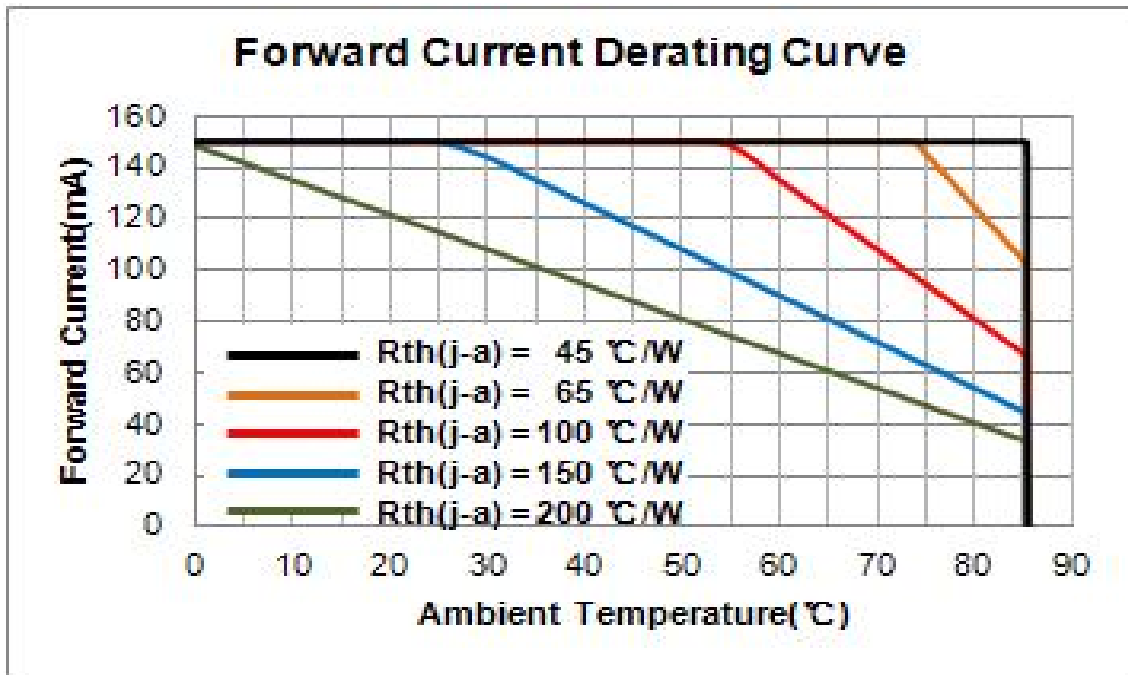

### 6) Beam Angle Characteristics

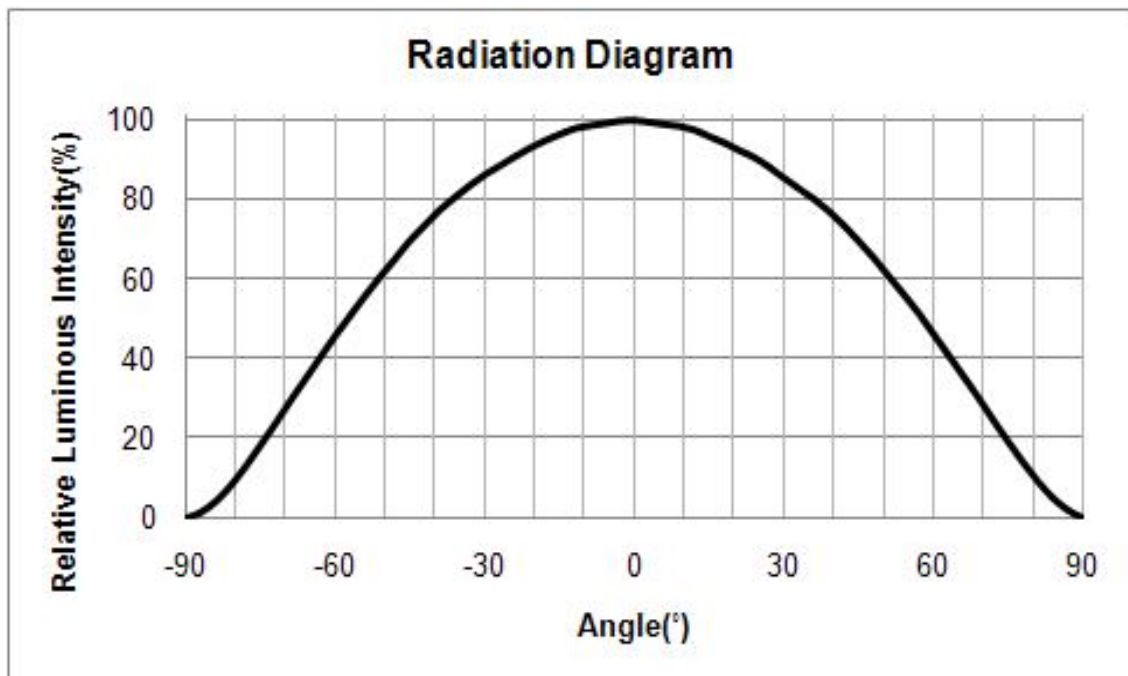

## 4. Outline Drawing & Dimension

1. Tolerance is  $\pm 0.10$  mm
2. The maximum compressing force is 15N on the body (a)
3. Do not place pressure on the encapsulation resin (b)

Left Side View

Top View

Bottom View

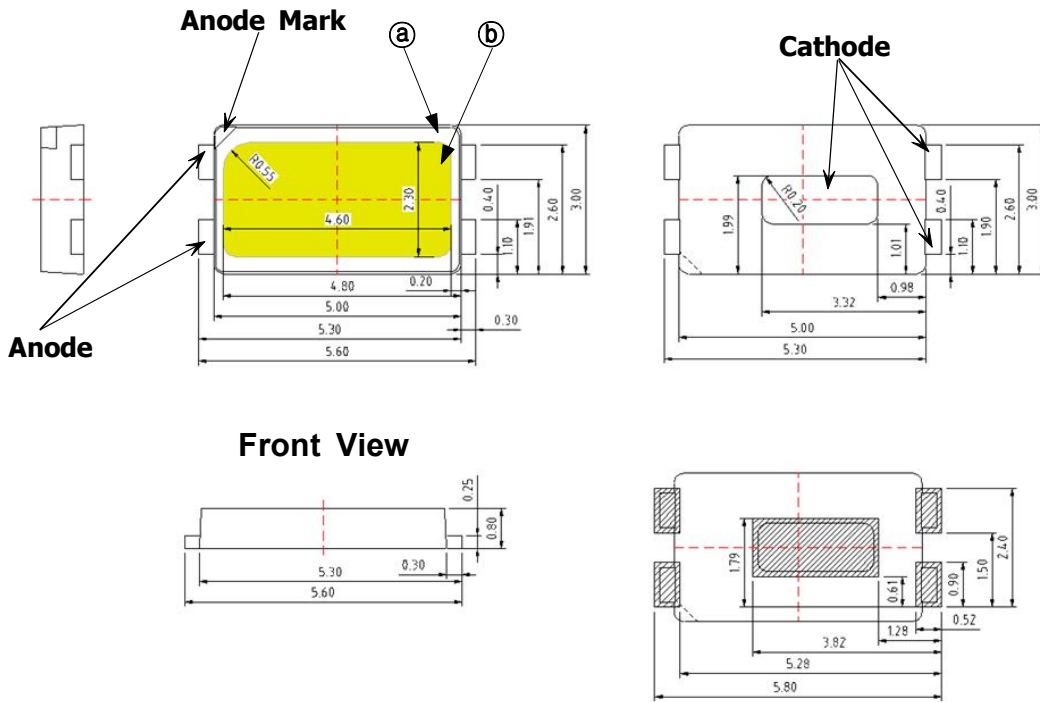

### Recommended Land Pattern

#### Notes:

- 1) This LED has built-in ESD protection device(s) connected in parallel to LED Chip(s).
- 2) Ts point & measurement method
  - ① Measure the nearest point to the thermal pad. If necessary, remove PSR of PCB to reach Ts point.
  - ② Thermal pad must be soldered to the PCB to dissipate heat properly. Otherwise, LED can be damaged.
- 3) Precautions
  - ① The pressure on the LEDs will influence to the reliability of the LEDs. Precautions should be taken to avoid the strong pressure on the LEDs. Do not put stress on the LEDs during heating.
  - ② Re-soldering should not be done after the LEDs have been soldered. If re-soldering is unavoidable, LED's characteristics should be carefully checked before and after such repair.
  - ③ Do not stack assembled PCBs together. Since materials of LEDs is soft, abrasion between two PCB assembled with LED might cause catastrophic failure of the LEDs.

## 5. Reliability Test Items and Conditions

### 1) Test Items

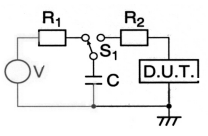
Test Item	Test Conditions	Test Hours/Cycles	Sample No	
MSL Test	125 °C 24hrs drying → 60 °C, 60 %RH 120hrs → 260 °C 10sec 3 cycles	1 cycle	11	
Room Temperature life test	25 °C±3 °C, DC150 mA	1,000 hrs	22	
High Temperature life test	85 °C±3 °C, DC150 mA	1,000 hrs	22	
High Temperature humidity life test	85 °C±3 °C, 85 %±2 %RH, DC150 mA	1,000 hrs	22	
Low Temperature life test	-40 °C±3 °C, DC150 mA	1,000 hrs	22	
Powered Temperature Cycle test	-45°C/20 min ↔ 85°C/20 min, Sweep 100min cycle on/off: each 5 min, DC 150mA	100 cycle	22	
Thermal Shock	-45 °C/15 min ↔ 125 °C/15 min → Hot plate 180 °C	500 cycle	100	
High Temperature Storage	Ta=120 °C±3 °C	1000 hrs	11	
Low Temperature Storage	Ta=-40 °C±3 °C	1000 hrs	11	
ESD(HBM)		R1:10 MΩ, R2:1.5 kΩ, C:100 pF, V = ±5 kV	5 times	5
ESD(MM)		R1:10 MΩ, R2: 0, C:200 pF, V = ±0.5 kV	5 times	5
Vibration Test	20~2000~20 Hz 200 m/SZ, Sweep 4 min X, Y, Z 3 direction, each 1 cycle	4 cycles	11	
Mechanical Shock Test	1500G, 0.5 ms, 3 shocks each X-Y-Z axis	5 cycles	11	

### 2) Criteria for Judging the Damage

Item	Symbol	Test Condition	Limit	
			Min	Max
Forward Voltage	V <sub>F</sub>	I <sub>F</sub> = 65 mA	Init. Value*0.9	Init. Value*1.1
Luminous Flux	Φ <sub>v</sub>	I <sub>F</sub> = 65 mA	Init. Value*0.7	Init. Value*1.2

## 6. Solder Conditions

### 1) Reflow Conditions ( Pb Free )

Reflow Frequency : 2 times max.

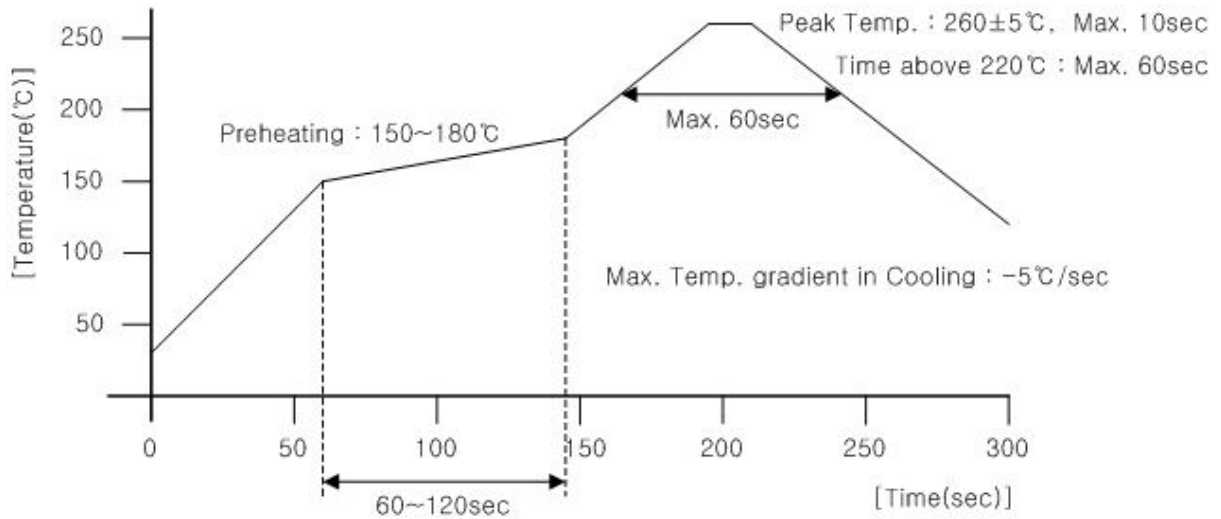

### 2) For Manual Soldering

Not more than 5 seconds @Max. 300°C, under soldering iron.



# 7. Tape & Reel

## 1) Taping Dimension

(unit : mm)

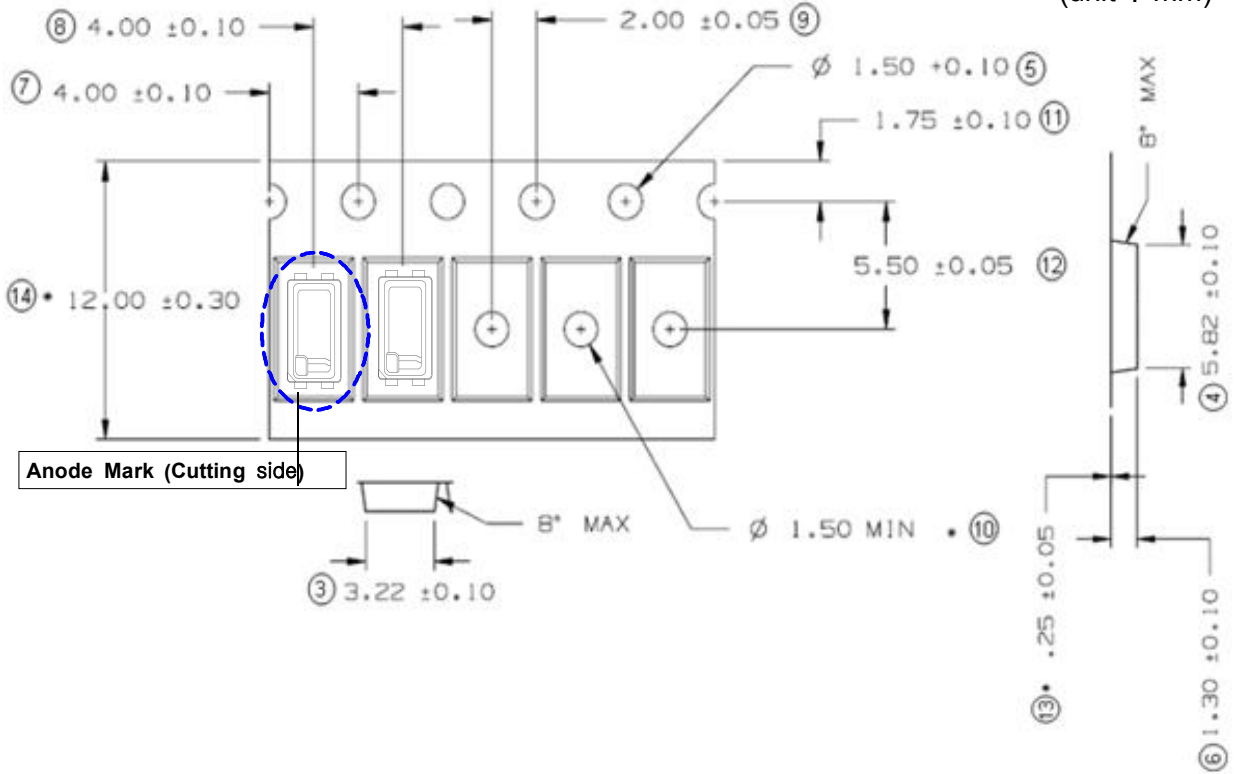

Tapping DIRECTION

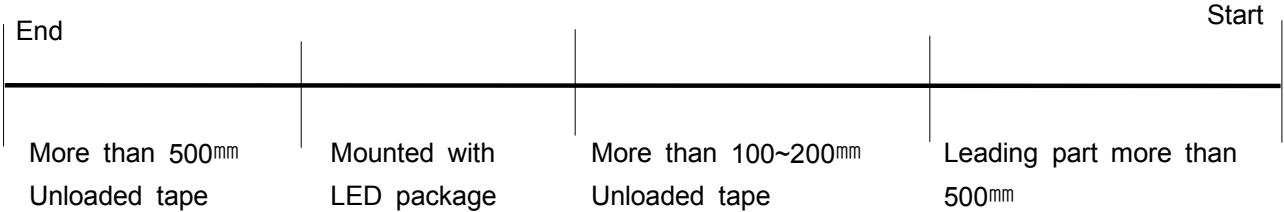

## 2) Reel

### 1) Reel Dimension (max 2,500 pcs)

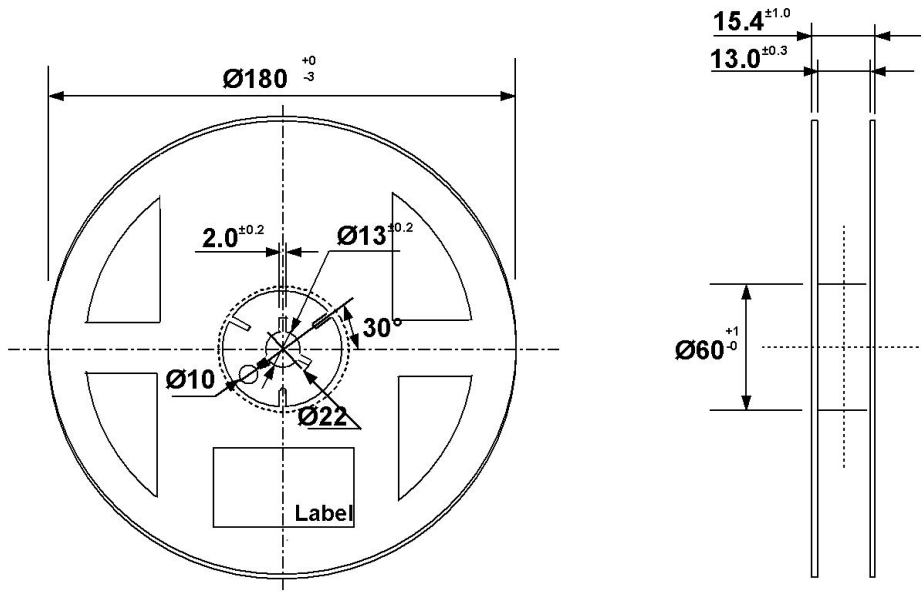

Tolerance  $\pm 0.2$  , Unit:mm

- (1) Quantity : The quantity/Reel to be 2,500 pcs.
- (2) Cumulative Tolerance : Cumulative tolerance/10 pitches to be  $\pm 0.2$ mm
- (3) Adhesion Strength of Cover Tape : Adhesion strength to be 0.1-0.7N when the cover tape is turned off from the carrier tape at  $10^\circ\text{C}$  angle to be the carrier tape.
- (4) Packaging : P/N, Manufacturing data code no. and quantity to be indicated on a damp proof Package.



## 8. Label Structure

### 1) Label Structure

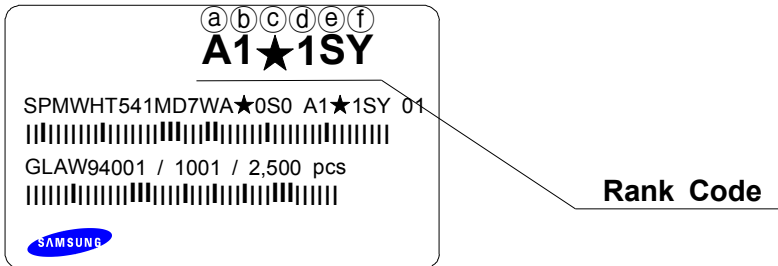

N.B) Denoted rank is the only example.

'★' means All kind of Chromaticity Coordinate Rank.

### Rank Code

- ⒶⒷ : Forward Voltage( $V_F$ ) Rank (refer to page. 7)
- ⒸⒹ : Chromaticity Coordinate Rank (refer to page. 5~6)
- ⒺⒻ : Luminous Flux( $\Phi_v$ , lm) Rank (refer to page. 3)

### 2) LOT Number

The Lot number is composed of the following characters

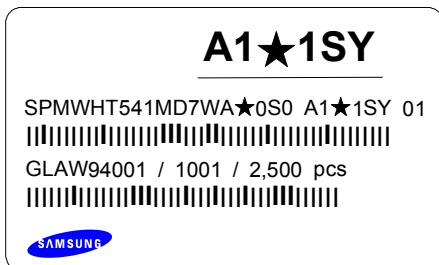

①②③④⑤⑥⑦⑧⑨ / 1ⒶⒷⒸ / 2,500 PCS

- ① : Production Site (S:SAMSUNG ELECTRONICS, G:TIAJIN CHINA)
- ② : L (LED)
- ③ : Product State (A:Normality, B:Bulk, C:First Production, R:Reproduction, S:Sample)
- ④ : Year (V:2011, W:2012, X:2013...)
- ⑤ : Month (1 ~ 9, A, B)
- ⑥ : Day (1 ~ 9, A, B ~ V)
- ⑦⑧⑨ : SAMSUNG ELECTRONICS LED Product number (1 ~ 999)
- ⒶⒷⒸ : Reel Number (1 ~ 999)



# 9. Packing Structure

## 1) Packing Process (The quantity of PKG on the Reel to be Max 2,500 pcs)

### Reel

**A1★1SY**

SPMWHT541MD7WA★0S0 A1★1SY 01

GLAW94001 / 1001 / 2,500 pcs

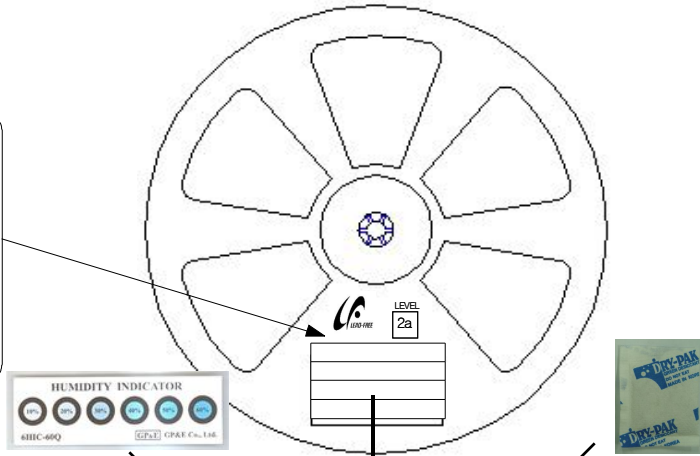

### Aluminum Vinyl Bag

**A1★1SY**

SPMWHT541MD7WA★0S0 A1★1SY 01

GLAW94001 / 1001 / 2,500 pcs

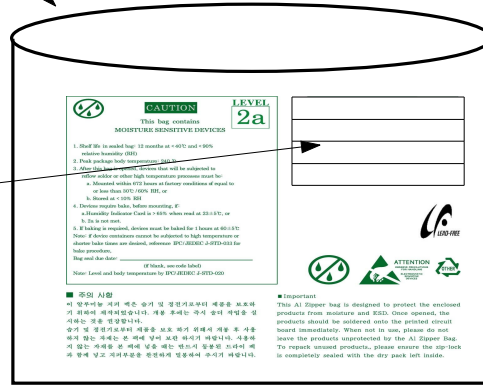

Material : Paper(SW3B(B))

TYPE	SIZE(mm)		
	L	W	H
7inch	245±5	220±5	182±5

① SIDE

**A1★1SY**

SPMWHT541MD7WA★0S0 A1★1SY 01

GLAW94001 / 1001 / 25,000 pcs

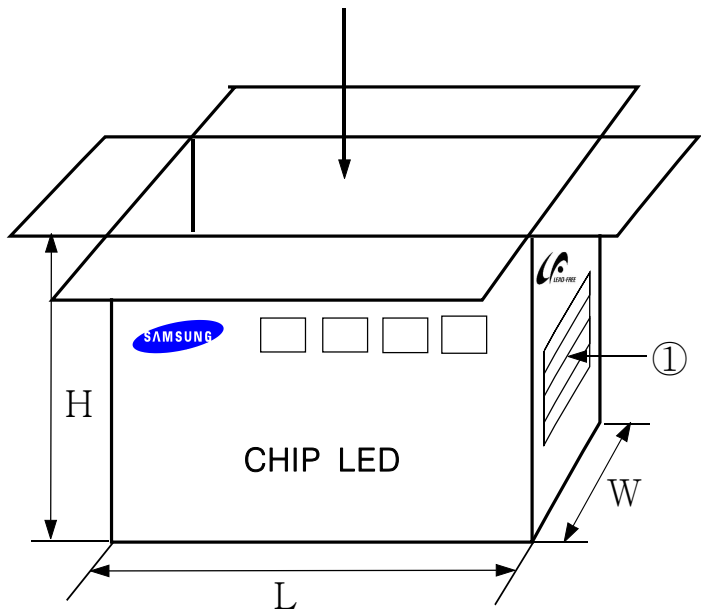

## 2) Aluminum Packing Bag



**CAUTION**

This bag contains  
**MOISTURE SENSITIVE DEVICES**

**LEVEL**

2a

1. Shelf life in sealed bag: 12 months at <math>< 40^{\circ}\text{C}</math> and <math>< 90\%</math> relative humidity (RH)
2. Peak package body temperature: 240 °C
3. After this bag is opened, devices that will be subjected to reflow solder or other high temperature processes must be:
  - a. Mounted within 672 hours at factory conditions of equal to or less than 30°C / 60% RH, or
  - b. Stored at <math>< 10\%</math> RH
4. Devices require bake, before mounting, if:
  - a. Humidity Indicator Card is > 65% when read at 23±5°C, or
  - b. 2a is not met.
5. If baking is required, devices must be baked for 1 hours at 60±5°C

Note: if device containers cannot be subjected to high temperature or shorter bake times are desired, reference IPC/JEDEC J-STD-033 for bake procedure,

Bag seal due date: \_\_\_\_\_  
(if blank, see code label)

Note: Level and body temperature by IPC/JEDEC J-STD-020



**A1★1SY**

SPMWHT541MD7WA★0S0 A1★1SY 01

GLAW94001 / 1001 / 2,500 pcs





**주의 사항**

이 알루미늄 지퍼 백은 습기 및 정전기로부터 제품을 보호하기 위하여 제작되었습니다. 개봉 후에는 즉시 솔더 작업을 실시하는 것을 권장합니다.

습기 및 정전기로부터 제품을 보호 하기 위해서 개봉 후 사용하지 않는 자재는 본 팩에 넣어 보관 하시기 바랍니다. 사용하지 않는 자재를 본 팩에 넣을 때는 반드시 동봉된 드라이 팩과 함께 넣고 지퍼부분을 완전하게 밀봉하여 주시기 바랍니다.

**Important**

This Al Zipper bag is designed to protect the enclosed products from moisture and ESD. Once opened, the products should be soldered onto the printed circuit board immediately. When not in use, please do not leave the products unprotected by the Al Zipper Bag. To repack unused products., please ensure the zip-lock is completely sealed with the dry pack left inside.

### Silica gel & Humidity Indicator Card in Aluminum Vinyl Bag

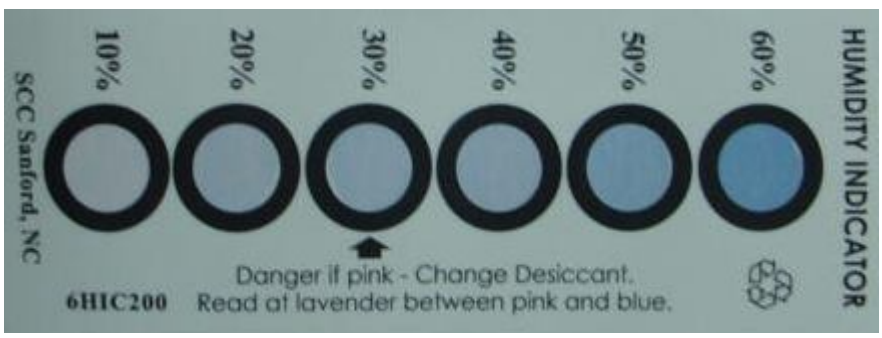

## 10. Precaution for use

- 1) For over-current-proof function, customers are recommended to apply resistors to prevent sudden change of the current caused by slight shift of the voltage.

과전류 방지를 위해 전압의 미세한 이동에 의해 야기되는 전류의 순간 변화를 방지하기 위해 저항 등의 설치를 권장함.

- 2) This device should not be used in any type of fluid such as water, oil, organic solvent, etc. When washing is required, IPA is recommended to use.

제품은 물, 오일, 유기물과 같은 액체 타입에서의 사용은 제한되며, 세정이 필요할 시에는 IPA 사용을 권장함.

- 3) When the LEDs illuminate, operating current should be decided after considering the ambient maximum temperature.

LED의 발광 시, 동작 전류는 주변 최고온도를 고려하여 결정되어야 함.

- 4) LEDs must be stored in a clean environment.

If the LEDs are to be stored for 3 months or more after being shipped from Samsung Electronics, they should be packed by a sealed container with nitrogen gas injected. (Shelf life of sealed bags: 12 months, temp.  $\sim 40^{\circ}\text{C}$ ,  $\sim 90\%RH$ )

LED의 보관은 청정한 환경에서 보존되어야 하며, 만약 삼성전자로부터 공급받는 후 3개월 또는 그 이상 보관이 필요하다면 질소 가스를 동봉한 보존용기에 보관되어야 함. (보존 bag의 수명 : 12 개월, 보존 온도  $\sim 40^{\circ}\text{C}$ , 습도  $\sim 90\%RH$ )

- 5) After storage bag is open, device subjected to soldering, solder reflow, or other high temperature processes must be:

보존 Bag이 개봉된 후에, 납땀이나 reflow 등의 높은 온도에 노출되는 제품은 다음의 사항에 부합되어야 함.

- a. Mounted within 672 hours(28 days) at an assembly line with a condition of no more than  $30^{\circ}\text{C}/60\%RH$ ,

- a. 제품은  $30^{\circ}\text{C}/60\%RH$ 보다 같거나 낮은 조립조건에서 672시간(28일)이내에 조립해야 함.

- b. Stored at  $<10\%RH$ .

- b. 10% 이하의 상대습도에서 보관되어야 함.

- 6) Repack unused Products with anti-moisture packing, fold to close any opening and then store in a dry place.

사용하지 않은 제품은 방습팩에 넣어 개봉 부위를 닫아서 다시 포장한 후, 건조한 장소에서 보관할 것을 권장함.

7) Devices require baking before mounting, if humidity card reading is  $>60\%$  at  $23\pm 5^{\circ}\text{C}$ .  
만약 습도표시카드의 수치가  $23\pm 5^{\circ}\text{C}$ 에서  $60\%$  이상이라면, 제품 실장 전 **baking**해야 함.

8) Devices must be baked for 1 hour at  $60\pm 5^{\circ}\text{C}$ , if baking is required.  
만약 **baking**이 필요하다면, 제품은  $60\pm 5^{\circ}\text{C}$ 에서 1시간 정도 **baking** 되어야 함.

9) The LEDs are sensitive to the static electricity and surge. It is recommended to use a wrist band or anti-electrostatic glove when handling the LEDs.  
LED는 정전기 및 서지에 민감한 제품이므로, LED 제품을 다룰 시에는 정전기 방지장갑이나 손목밴드를 사용하기를 권장함.

If voltage exceeding the absolute maximum rating is applied to LEDs, it may cause damage or even destruction to LED devices.

만약 절대 허용치를 초과하는 전압이 LED에 가해지면, LED 소자는 파괴되거나 손상될 수 있음.

Damaged LEDs may show some unusual characteristics such as increase in leak current, lowered turn-on voltage, or abnormal lighting of LEDs at low current.

손상된 제품은 누설전류의 증가, Turn on 전압의 저하, 저 전류에서의 점등불량 등의 이상 거동을 보일 수 있음.

10) VOCs (volatile organic compounds) can be generated from adhesives, flux, hardener or organic additives used in luminaires (fixtures).

Transparent LED silicone encapsulant is permeable to those chemicals and they may lead a discoloration of encapsulant when they expose to heat or light.

VOCs(휘발성 유기 화합물)는 등기구에 사용되는 접착제, Flux, 경화제, 유기물 첨가제에서 발생하여 LED 실리콘 봉지체를 투과하고, 빛 또는 열에 노출되었을 때 변색이 발생 할 수 있음.

This phenomenon can cause a significant loss of light emitted(output) from the luminaires(fixture).

이러한 현상은 등기구로부터 나오는 빛의 중대한 손실을 줄 수 있음.

In order to prevent these problems, we recommend you to know the physical properties of the materials used in luminaires, They must be selected carefully.

이러한 문제 발생 방지를 위해서, 등기구에 사용되는 자재에 대한 물성을 알고 주의하여 선택 되어야함.

### 11) Risk of Sulfurization (or Tarnishing)

The LED from Samsung Electronics uses a silver-plated lead frame and its surface color may change to black(or dark colored) when it is exposed to sulfur(S), chlorine (Cl) or other halogen compound.

삼성전자의 LED는 Ag(은)을 도금한 리드프레임을 사용함. 이 리드프레임의 표면이 황(S), 염소(Cl), 또는 다른 할로겐 화합물들에 노출시 Ag(은)은 검정(또는 어두운색)으로 바뀔 수 있음.

Sulfurization of lead frame may cause intensity degradation, change of chromaticity coordinates and, in extreme cases, open circuit. It requires caution.

리드 프레임의 황화(Sulfurization)는 광량 저하, 색좌표 변화 및 심한 경우 LED 무등(Open) 불량을 일으킬 수도 있으니 주의가 필요함.

Due to possible sulfurization of lead frame, LED should not be used and stored together with oxidizing substances made of materials in a following list,  
: Rubber, plain paper, lead solder cream and so on.

리드 프레임 황화(Sulfurization)의 근원이 될 수 있으니 LED는 아래의 목록으로 만들어진 산화성 물질들과 함께 저장, 사용이 불가함 : 고무, 일반 종이, 납땜 크림 등



# 11. Hazard Substance Analysis

## 1) RoHS



**Test Report No.** F690101/LF-CTSAAYA13-34757

Issued Date: 2013. 07. 25 Page 1 of 7

To: SAMSUNG ELECTRONICS CO., LTD.  
129, Samsung-ro  
Youngtong-gu  
Suwon-si  
Gyeonggi-do  
Korea

The following merchandise was submitted and identified by the client as :

SGS File No.	: AYA13-34757
Product Name	: S630 G2 CR100
Item No./Part No.	: N/A
Received Date	: 2013. 07. 18
Test Period	: 2013. 07. 19 to 2013. 07. 25
Test Results	: For further details, please refer to following page(s)
Test Performed	: SGS Korea tested the sample(s) selected by applicant with following results.
Job Comments	: By the applicant's specific request, the sampling and testing was performed only for the part indicated in the photo without disassembly.

Timothy Jeon  
Jinhee Kim  
Cindy Park  
Jerry Jung/ Testing Person

SGS Korea Co., Ltd.  
  
Jeff Jang / Chemical Lab Mgr

\* This document is issued by the Company subject to its General Conditions of Service which are available on request at: [www.sgs.com](http://www.sgs.com). The Company is not responsible for the results of this analysis if the sample is not representative of the material to be tested. The Company's liability is limited to the amount of the fee paid for the analysis. The Company is not responsible for the results of this analysis if the sample is not representative of the material to be tested. The Company's liability is limited to the amount of the fee paid for the analysis. The Company is not responsible for the results of this analysis if the sample is not representative of the material to be tested. The Company's liability is limited to the amount of the fee paid for the analysis.

Test Report No. F690101.A.F-CTSAYA.A13-34757

Issued Date: 2013. 07. 25 Page 2 of 7

Sample No. : AYAA13-34757.001  
 Sample Description : 6630 G2 CR90  
 Item No./Part No. : N/A  
 Materials : N/A

**Heavy Metals**

Test Item	Unit	Test Method	MDL	Results
Cadmium (Cd)	mg/kg	With reference to IEC 62321:2008, ICP	0.5	N.D.
Lead (Pb)	mg/kg	With reference to IEC 62321:2008, ICP	5	N.D.
Mercury (Hg)	mg/kg	With reference to IEC 62321:2008, ICP	2	N.D.
Hexavalent Chromium (Cr VI)	mg/kg	With reference to IEC 62321:2008, UV/VIS	1	N.D.
Antimony (Sb)	mg/kg	With reference to EPA3052(1996), US EPA 6010B(1996), ICP	10	N.D.
Arsenic (As)	mg/kg	With reference to EPA3052(1996), US EPA 6010B(1996), ICP	10	N.D.
Beryllium (Be)	mg/kg	With reference to EPA3052(1996), US EPA 6010B(1996), ICP	0.5	N.D.

**Flame Retardants-PBBs/PBDEs**

Test Item	Unit	Test Method	MDL	Results
Monebromobiphenyl	mg/kg	With reference to IEC 62321:2008, GC-MS	5	N.D.
Dibromobiphenyl	mg/kg	With reference to IEC 62321:2008, GC-MS	5	N.D.
Tribromobiphenyl	mg/kg	With reference to IEC 62321:2008, GC-MS	5	N.D.
Tetrabromobiphenyl	mg/kg	With reference to IEC 62321:2008, GC-MS	5	N.D.
Pentabromobiphenyl	mg/kg	With reference to IEC 62321:2008, GC-MS	5	N.D.
Hexabromobiphenyl	mg/kg	With reference to IEC 62321:2008, GC-MS	5	N.D.
Heptabromobiphenyl	mg/kg	With reference to IEC 62321:2008, GC-MS	5	N.D.
Octabromobiphenyl	mg/kg	With reference to IEC 62321:2008, GC-MS	5	N.D.
Nonabromobiphenyl	mg/kg	With reference to IEC 62321:2008, GC-MS	5	N.D.
Decabromobiphenyl	mg/kg	With reference to IEC 62321:2008, GC-MS	5	N.D.
Monebromodiphenyl ether	mg/kg	With reference to IEC 62321:2008, GC-MS	5	N.D.
Dibromodiphenyl ether	mg/kg	With reference to IEC 62321:2008, GC-MS	5	N.D.
Tribromodiphenyl ether	mg/kg	With reference to IEC 62321:2008, GC-MS	5	N.D.
Tetrabromodiphenyl ether	mg/kg	With reference to IEC 62321:2008, GC-MS	5	N.D.
Pentabromodiphenyl ether	mg/kg	With reference to IEC 62321:2008, GC-MS	5	N.D.
Hexabromodiphenyl ether	mg/kg	With reference to IEC 62321:2008, GC-MS	5	N.D.

NOTE:

- (1) N.D. = Not detected.(<MDL)
- (2) mg/kg = ppm
- (3) MDL = Method Detection Limit
- (4) - = No regulation
- (5) Negative = Undetectable / Positive = Detectable
- (6) \*\* = Qualitative analysis (No Unit)
- (7) \* = Boiling-water-extraction:

Negative = Absence of CrVI coating  
 Positive = Presence of CrVI coating; the detected concentration in boiling-water-extraction solution is equal or greater than 0.02 mg/kg with 50 cm2 sample surface area.

\* This document is issued by the Company subject to the General Conditions of Service which are available on request at [www.sgs.com](http://www.sgs.com) or by electronic based communication, subject to Terms and Conditions, in the website [www.sgs.com](http://www.sgs.com), of which it forms an integral part. The Company's liability is limited to the extent of the fees paid for the analysis. The Company's liability is limited to the extent of the fees paid for the analysis. The Company's liability is limited to the extent of the fees paid for the analysis. The Company's liability is limited to the extent of the fees paid for the analysis.

Test Report No. F690101ALF-CTSA YAA A13-34757

Issued Date: 2013. 07. 25 Page 3 of 7

Sample No. : AYAA13-34757.001  
 Sample Description : 5630 G2 CR100  
 Item No./Part No. : N/A  
 Materials : N/A

## Flame Retardants-PBBs/PBDEs

Test Item	Unit	Test Method	MDL	Results
Heptabromodiphenyl ether	mg/kg	With reference to IEC 62321:2008, GC-MS	5	N.D.
Octabromodiphenyl ether	mg/kg	With reference to IEC 62321:2008, GC-MS	5	N.D.
Nonabromodiphenyl ether	mg/kg	With reference to IEC 62321:2008, GC-MS	5	N.D.
Decabromodiphenyl ether	mg/kg	With reference to IEC 62321:2008, GC-MS	5	N.D.

## Halogen Content

Test Item	Unit	Test Method	MDL	Results
Bromine(Br)	mg/kg	BS EN 14682:2007, IC	30	N.D.
Chlorine(Cl)	mg/kg	BS EN 14682:2007, IC	30	N.D.
Fluorine(F)	mg/kg	BS EN 14682:2007, IC	30	68
Iodine(I)	mg/kg	BS EN 14682:2007, IC	50	N.D.

## Organotin Compounds

Test Item	Unit	Test Method	MDL	Results
Tributyltin (TBT)	mg/kg	DIN 38407-13, GC/MS	1	N.D.
Triphenyltin (TPHT)	mg/kg	DIN 38407-13, GC/MS	1	N.D.
Dibutyltin (DBT)	mg/kg	DIN 38407-13, GC/MS	1	N.D.
Dioctyltin(DOT)	mg/kg	DIN 38407-13, GC/MS	1	N.D.
Monobutyltin (MBT)	mg/kg	DIN 38407-13, GC/MS	1	N.D.
Bis (tributyltin)oxide (TBTO)	mg/kg	DIN 38407-13, GC/MS	1	N.D.
Monooctyltin(MOT)	mg/kg	DIN 38407-13, GC/MS	1	N.D.
Tetrabutyltin (TeBT)	mg/kg	DIN 38407-13, GC/MS	1	N.D.

## Other(s)

Test Item	Unit	Test Method	MDL	Results
PFOS (Perfluorooctane Sulfonates-Acid/Metal Salt/Amide)	mg/kg	US EPA3540 C/3560 C, LC/MS	1	N.D.

## NOTE:

- (1) N.D. = Not detected.(<MDL)
- (2) mg/kg = ppm
- (3) MDL = Method Detection Limit
- (4) - = No regulation
- (5) Negative = Undetectable / Positive = Detectable
- (6) \*\* = Qualitative analysis (No Unit)
- (7) \* = Boiling-water-extraction:  
 Negative = Absence of CrVI coating  
 Positive = Presence of CrVI coating; the detected concentration in boiling-water-extraction solution is equal or greater than 0.02 mg/kg with 50 cm<sup>2</sup> sample surface area.

\*This document is issued by the Company subject to its General Conditions of Service which are available on request at [www.sgs.com](http://www.sgs.com) or [sgs@sgs.com](mailto:sgs@sgs.com). It is strictly confidential and intended for the use of the Client only. It is the Client's responsibility to ensure that the information contained herein is accurate and complete. The Company's liability is limited to the extent of the services provided. The Company is not responsible for any damage or loss of data or information resulting from the use of the services provided. The Company is not responsible for any damage or loss of data or information resulting from the use of the services provided. The Company is not responsible for any damage or loss of data or information resulting from the use of the services provided.

FDS2 Version 6

SGS Korea Co., Ltd.

322, The Q Valley, 555-9, Haebye-dong, Daejeon-gu, Anyang-si, Gyeonggi-do, Korea 431-1000  
 t: +82 (0)91 4 800 0000 - f: +82 (0)91 480 0 050 <http://www.sgs.com> / [sgs@sgs.com](mailto:sgs@sgs.com)

Member of the SGS Group (Société Générale de Surveillance)



Test Report No. F690101/LF-CTSA/A.13-34757

Issued Date: 2013. 07. 25 Page 4 of 7

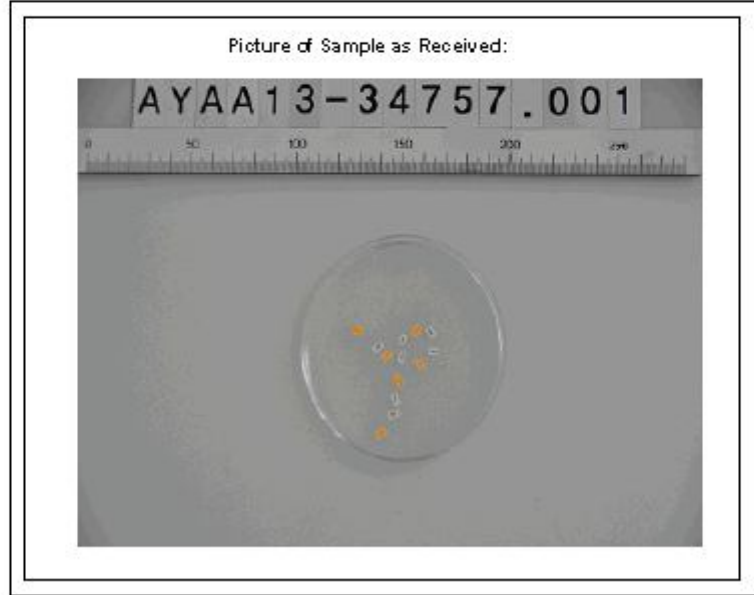

NOTE:

- (1) N.D. = Not detected.(<MDL)
- (2) mg/kg = ppm
- (3) MDL= Method Detection Limit
- (4) - = No regulation
- (5) Negative = Undetectable / Positive = Detectable
- (6)\*\* = Qualitative analysis (No Unit)
- (7)\* = Boiling-water-extraction:  
 Negative = Absence of CrVI coating  
 Positive = Presence of CrVI coating; the detected concentration in boiling-water-extraction solution is equal or greater than 0.02 mg/kg with 50 cm<sup>2</sup> sample surface area.

\* We warrant to issue by the Company subject to its General Conditions of Service which are available on request at [www.sgs.com](http://www.sgs.com) or [www.sgs.com/sgs](http://www.sgs.com/sgs), its standards based services, subject to Terms and Conditions for Member Countries of [www.sgs.com/sgs](http://www.sgs.com/sgs) and Member States in the Member of State, its services and its services based on the basis of the Company's Service of the Site of its Member of State and the Member of State's Institution, it may. The Company will not be responsible for its Client's use of the services, and it is not possible to be held liable for its services. The Company's Service of the Site of its Member of State and the Member of State's Institution, it may be held liable for the results of its services. The Company's Service of the Site of its Member of State and the Member of State's Institution, it may be held liable for the results of its services. The Company's Service of the Site of its Member of State and the Member of State's Institution, it may be held liable for the results of its services.

F052 Version 6

SGS Korea Co., Ltd.

522, The G Valley, 555-3, Hageye-dong, Dongan-gu, Anyang-si, Gyeonggi-do, Korea 431-030  
 t: 82 (0)1 4 800 000 - f: 82 (0)1 4 803 059 j: [inquiry@sgskorea.com](mailto:inquiry@sgskorea.com) / [sgskorea@sgskorea.com](mailto:sgskorea@sgskorea.com)

Member of the SGS Group (Société Générale de Surveillance)



Testing Flow Chart for RoHS: Cd/Pb/Hg/Cr<sup>6+</sup> /PBBs & PBDEs Testing

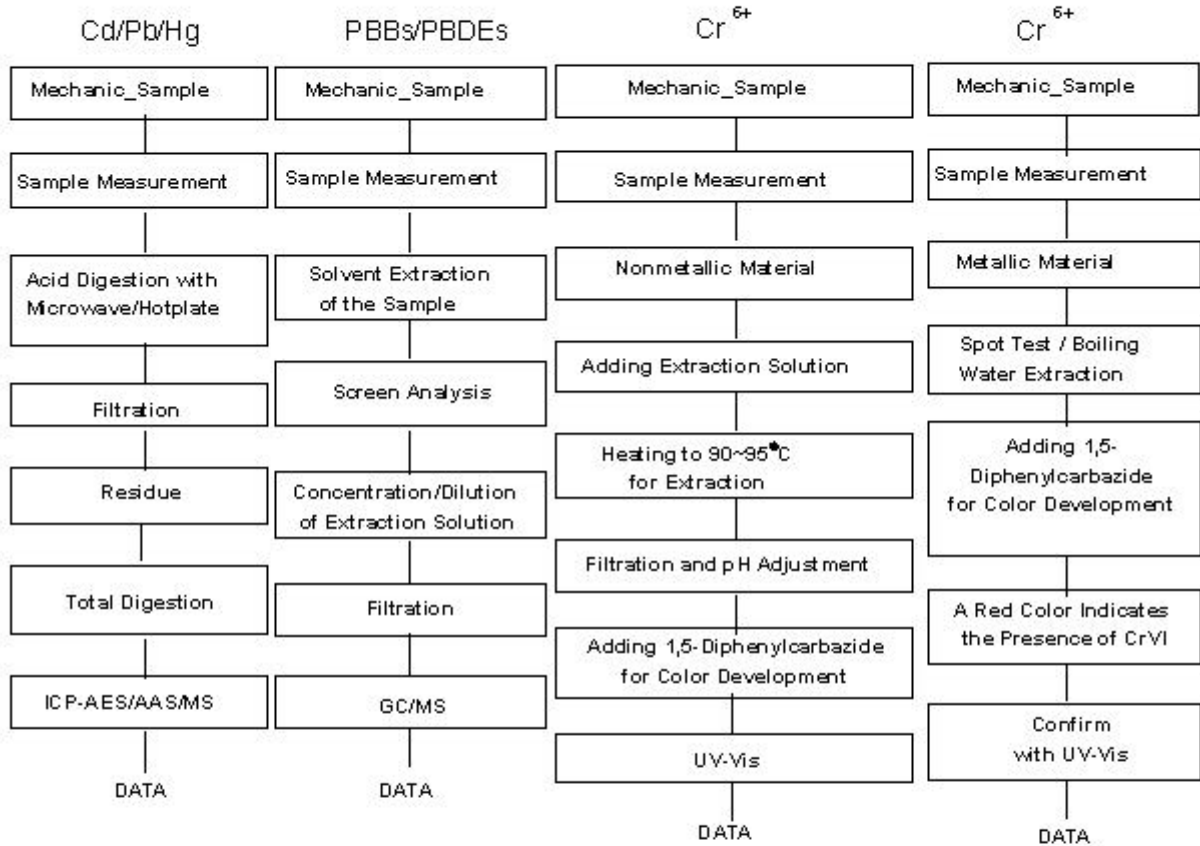

The samples were dissolved totally by pre-conditioning method according to above flow chart for Cd,Pb,Hg.  
Section Chief : Gilsae Yi

NOTE:

- (1) N.D. = Not detected(<MDL)
- (2) mg/kg = ppm
- (3) MDL = Method Detection Limit
- (4) - = No regulation
- (5) Negative = Undetectable / Positive = Detectable
- (6) \*\* = Qualitative analysis (No Unit)
- (7) \* = Boiling-water-extraction:  
 Negative = Absence of CrVI coating  
 Positive = Presence of CrVI coating; the detected concentration in boiling-water-extraction solution is equal or greater than 0.02 mg/kg with 50 cm<sup>2</sup> sample surface area.

1% measured in Korea by the Company subject to the Consent Certificate of Korean public analyst, available on request at <http://www.samsungled.com>, for standards based measurement, subject to terms and conditions for Standards Compliance of [www.samsungled.com](http://www.samsungled.com), if further is required in the field of RoHS, Environmental and Sustainable Issues, unless there is any notice of RoHS compliance in the field of RoHS, including, if any, the Company's own responsibility to be in RoHS compliance. 1% measured in Korea, not in Korea public, for a standard based measurement of RoHS compliance, unless the Company's notice of the field of RoHS, including, if any, the Company's own responsibility to be in RoHS compliance. 1% measured in Korea, not in Korea public, for a standard based measurement of RoHS compliance, unless the Company's notice of the field of RoHS, including, if any, the Company's own responsibility to be in RoHS compliance. 1% measured in Korea, not in Korea public, for a standard based measurement of RoHS compliance, unless the Company's notice of the field of RoHS, including, if any, the Company's own responsibility to be in RoHS compliance.





**Flow Chart for Inorganic Elements Testing**

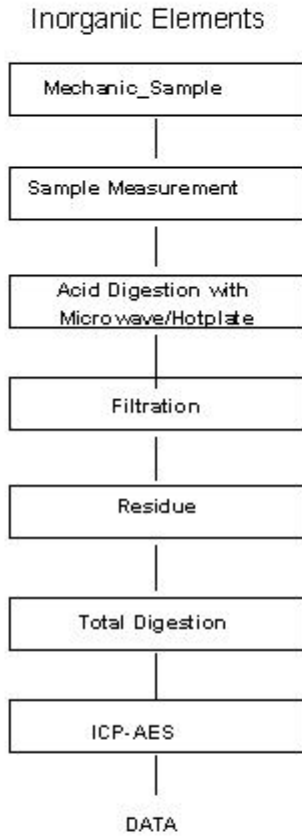

**NOTE:**

- (1) N.D. = Not detected.(<MDL)
- (2) mg/kg = ppm
- (3) MDL= Method Detection Limit
- (4) - = No regulation
- (5) Negative = Undetectable / Positive = Detectable
- (6)\*\* = Qualitative analysis (No Unit)
- (7)\* = Boiling-water-extraction:  
 Negative = Absence of Cr(VI) coating  
 Positive = Presence of Cr(VI) coating; the detected concentration in boiling-water-extraction solution is equal or greater than 0.02 mg/kg with 50 cm<sup>2</sup> sample surface area.

\* This document is issued by the Company subject to the General Conditions of Service which are available on request at: [www.samsung.com](http://www.samsung.com). The Company is not responsible for any loss or damage caused by the use of this document or the information contained therein. The Company is not responsible for any loss or damage caused by the use of this document or the information contained therein. The Company is not responsible for any loss or damage caused by the use of this document or the information contained therein. The Company is not responsible for any loss or damage caused by the use of this document or the information contained therein. The Company is not responsible for any loss or damage caused by the use of this document or the information contained therein.



Flow Chart for Halogen Test

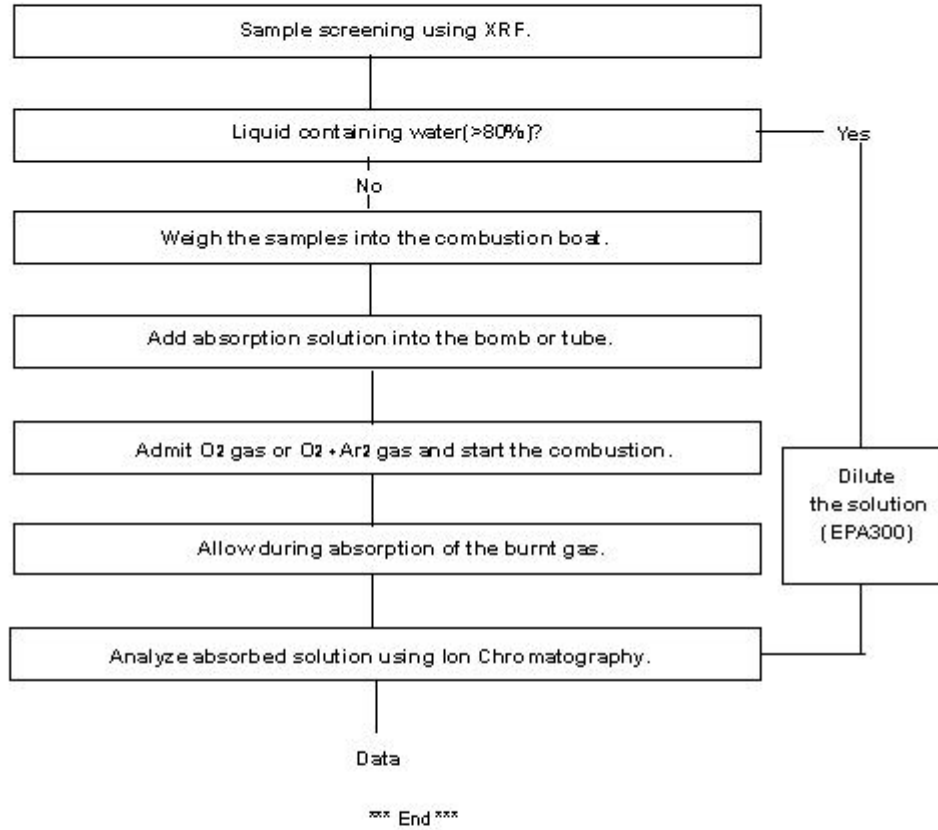

NOTE:

- (1) N.D. = Not detected.(<MDL)
- (2) mg/kg = ppm
- (3) MDL = Method Detection Limit
- (4) - = No regulation
- (5) Negative = Undetectable / Positive = Detectable
- (6) \*\* = Qualitative analysis (No Unit)
- (7) \* = Boiling-water-extraction:  
 Negative = Absence of Cr(VI) coating  
 Positive = Presence of Cr(VI) coating; the detected concentration in boiling-water-extraction solution is equal or greater than 0.02 mg/kg with 50 cm<sup>2</sup> sample surface area.

\*\*\* In accordance with the terms of the General Conditions of Service which are available at [www.sgs.com](http://www.sgs.com), the Client hereby acknowledges that the results of the analysis are for information only and do not constitute a warranty or a guarantee of any kind. The Client is responsible for the accuracy of the data and the reliability of the results. The Client is also responsible for the accuracy of the data and the reliability of the results. The Client is also responsible for the accuracy of the data and the reliability of the results. The Client is also responsible for the accuracy of the data and the reliability of the results.

## 2) REACH (SVHC)



Test Report No. F690101/LF-CTSAYAA13-34756 Issued Date: 2013. 07. 25 Page 1 of 15

To: **SAMSUNG ELECTRONICS CO., LTD.**  
129 Samsung-ro  
Youngtong-gu  
Suwon-si  
Gyeonggi-do  
Korea

The following sample(s) was/were submitted and identified by/on behalf of the client as:-

<b>Product Name</b>	: 5630 G2 CR190
<b>Item/Part Name</b>	: N/A
<b>SGS File No.</b>	: AYAA13-34756
<b>Received Date</b>	: 2013. 07. 18
<b>Test Period</b>	: 2013. 07. 19 ~ 2013. 07. 25
<b>Test Performed</b>	: SGS Korea tested the sample(s) selected by applicant with following results
<b>Test Requested</b>	: One hundred-forty four (144) substances in the Candidate List of Substances of Very High Concern (SVHC) for authorization published by European Chemicals Agency (ECHA) on June 20, 2013 regarding Regulation (EC) No 1907/2006 concerning the REACH.
<b>Test Method</b>	: Please refer to next page(s).
<b>Test Result(s)</b>	: Please refer to next page(s).

Timothy Jeon  
Cindy park  
Jinhee Kim  
Sophia Kim  
/Testing Person

SGS Korea Co., Ltd



Jeff Jang / Chemical Lab Mgr

\* This document has been prepared by the Company and is to be used for reference only. It is not intended to be used as a basis for any legal action. The Company shall not be liable for any damage or loss caused by the use of this document. The Company shall not be liable for any damage or loss caused by the use of this document. The Company shall not be liable for any damage or loss caused by the use of this document.





**Test Result(s)**

Substance Name	CAS number	EC number	Concentration (%)	Reporting Limit (%)	Classification
Alkanes, C10-13, chloro (Short Chain Chlorinated Paraffins)	85535-84-8	287-476-5	N.D.	0.05	PBT
Anthracene	120-12-7	204-371-1	N.D.	0.05	PBT
Benzyl butyl phthalate (BBP)	85-68-7	201-622-7	N.D.	0.05	Toxic for Reproduction
Bis(2-ethylhexyl)phthalate (DEHP)	117-81-7	204-211-0	N.D.	0.05	Toxic for Reproduction
Bis(tributyltin)oxide	56-35-9	200-268-0	N.D.	0.05	PBT
Cobalt dichloride*	7646-79-9	231-589-4	N.D.	0.005	Carcinogen Toxic for Reproduction
4,4-Diaminodiphenylmethane	101-77-9	202-974-4	N.D.	0.05	Carcinogen
Diarsenic pentaoxide*	1303-28-2	215-116-9	N.D.	0.005	Carcinogen
Diarsenic trioxide*	1327-53-3	215-481-4	N.D.	0.005	Carcinogen
Dibutyl phthalate (DBP)	84-74-2	201-557-4	N.D.	0.05	Toxic for Reproduction
Hexabromocyclododecane (HBCDD) and all major diastereoisomers identified ( $\alpha$ -HBCDD, $\beta$ -HBCDD, $\gamma$ -HBCDD)	25637-99-4 3194-55-6 (134237-51-7, 134237-50-6, 134237-52-8)	247-148-4 221-695-9	N.D.	0.05	PBT
Lead hydrogen arsenate*	7784-40-9	232-064-2	N.D.	0.005	Carcinogen Toxic for Reproduction
Sodium dichromate* (Sodium dichromate, dehydrate)	10588-01-9 (7789-12-0)	234-190-3	N.D.	0.005	Carcinogen Mutagen Toxic for Reproduction
5-tert-butyl-2,4,6-trinitro-m-xylene (musk xylene)	81-15-2	201-329-4	N.D.	0.05	vPvB
Triethyl arsenate*	15606-95-8	427-700-2	N.D.	0.005	Carcinogen

\* The substance listed by the Company is not in the Control List of the GHS, and is not classified as a hazardous substance under the GHS. However, it is classified as a hazardous substance under the GHS in some countries. The Company is not responsible for the classification of the substance in any country. The classification of the substance in any country is the responsibility of the user. The Company is not responsible for the classification of the substance in any country. The classification of the substance in any country is the responsibility of the user. The Company is not responsible for the classification of the substance in any country. The classification of the substance in any country is the responsibility of the user.

Substance Name	CAS number	EC number	Concentration (%)	Reporting Limit (%)	Classification
Di-isobutyl phthalate(DIBP)	84-69-5	201-553-2	N.D.	0.05	Toxic for Reproduction
2,4-Dinitrotoluene	121-14-2	204-450-0	N.D.	0.05	Carcinogen
Tris(2-chloroethyl) phosphate	115-96-8	204-118-5	N.D.	0.05	Toxic for Reproduction
Anthracene oil	90640-80-5	292-602-7	N.D.	0.05	PBT; vPvB Carcinogen
Anthracene oil, anthracene paste; distn. Lights	91995-17-4	295-278-5	N.D.	0.05	PBT; vPvB Carcinogen Mutagen
Anthracene oil, anthracene paste, anthracene fraction	91995-15-2	295-275-9	N.D.	0.05	PBT; vPvB Carcinogen Mutagen
Anthracene oil, anthracene-low	90640-82-7	292-604-8	N.D.	0.05	PBT; vPvB Carcinogen Mutagen
Anthracene oil, anthracene paste	90640-81-6	292-603-2	N.D.	0.05	PBT; vPvB Carcinogen Mutagen
Coal tar pitch, high temperature	65996-93-2	266-028-2	N.D.	0.05	PBT; vPvB Carcinogen
Lead sulfochromate yellow (C.I. Pigment Yellow 34)*	1344-37-2	215-693-7	N.D.	0.005	Carcinogen Toxic for Reproduction
Lead chromate molybdate sulfate red (C.I. Pigment Red 104)*	12656-85-8	235-759-9	N.D.	0.005	Carcinogen Toxic for Reproduction
Lead chromate*	7758-97-6	231-846-0	N.D.	0.005	Carcinogen Toxic for Reproduction
Acrylamide	79-06-01	201-173-7	N.D.	0.05	Carcinogen Mutagen

\*The numerical values by the Company subject to the General Conditions of Service unless indicated, available on our website at <http://www.sgs.com> or <http://www.sgs.com/sgsweb/sgsweb.nsf>. In absence thereof, subject to the General Conditions of Service of the Company, the numerical values by the Company are for the information of the Client, they do not constitute a guarantee of the accuracy of the results. The Client's attention is drawn to the fact that the numerical values by the Company are for the information of the Client, they do not constitute a guarantee of the accuracy of the results. The Client's attention is drawn to the fact that the numerical values by the Company are for the information of the Client, they do not constitute a guarantee of the accuracy of the results. The Client's attention is drawn to the fact that the numerical values by the Company are for the information of the Client, they do not constitute a guarantee of the accuracy of the results.

Substance Name	CAS number	EC number	Concentration (%)	Reporting Limit (%)	Classification
Boric acid*	10043-35-3 11113-50-1	233-139-2 234-343-4	N.D.	0.005	Toxic for Reproduction
Disodium tetraborate, anhydrous*	1330-43-4 12179-04-3 1303-96-4	215-540-4	N.D.	0.005	Toxic for Reproduction
Tetraboron disodium heptaoxide, hydrate*	12267-73-1	235-541-3	N.D.	0.005	Toxic for Reproduction
Trichloroethylene	79-01-6	201-167-4	N.D.	0.05	Carcinogen
Sodium chromate*	7775-11-3	231-889-5	N.D.	0.005	Carcinogen Mutagen Toxic for Reproduction
Ammonium dichromate*	7789-09-5	232-143-1	N.D.	0.005	Carcinogen Mutagen Toxic for Reproduction
Potassium dichromate*	7778-50-9	231-906-6	N.D.	0.005	Carcinogen Mutagen Toxic for Reproduction
Potassium chromate*	7789-00-6	232-140-5	N.D.	0.005	Carcinogen Mutagen

\*The manufacturer by the Company subject to its General Conditions of Sale has not provided a reliable certificate of analysis for the substances listed above, which is why they are not classified. In addition, the substances listed above are not classified by the Company as carcinogenic, mutagenic or toxic for reproduction. The Company's Declaration of the Results of the analysis is for information only and does not constitute a guarantee of the results. The Company's liability is limited to the accuracy of the information provided in the report. The Company's liability is limited to the accuracy of the information provided in the report. The Company's liability is limited to the accuracy of the information provided in the report. The Company's liability is limited to the accuracy of the information provided in the report.



Substance Name	CAS number	EC number	Concentration (%)	Reporting Limit (%)	Classification
Cobalt(II) sulphate*	10124-43-3	233-334-2	N.D.	0.005	Carcinogen Toxic for Reproduction
Cobalt(II) dinitrate*	10141-05-6	233-402-1	N.D.	0.005	Carcinogen Toxic for Reproduction
Cobalt(II) carbonate*	513-79-1	208-169-4	N.D.	0.005	Carcinogen Toxic for Reproduction
Cobalt(II) diacetate*	71-48-7	200-755-8	N.D.	0.005	Carcinogen Toxic for Reproduction
2-Methoxyethanol	109-86-4	203-713-7	N.D.	0.05	Toxic for Reproduction
2-Ethoxyethanol	110-80-5	203-804-1	N.D.	0.05	Toxic for Reproduction
Chromium trioxide*	1333-82-0	215-607-8	N.D.	0.005	Carcinogen Mutagen
Acids generated from chromium trioxide and their oligomers:  Chromic acid Dichromic acid  Oligomers of chromic acid and dichromic acid*	7738-94-5 13530-68-2 -	231-801-5 236-881-5 -	N.D.	0.005	Carcinogen
1-methyl-2-pyrrolidone	872-50-4	212-828-1	N.D.	0.05	Toxic for Reproduction
2-ethoxyethyl acetate	111-15-9	203-839-2	N.D.	0.05	Toxic for Reproduction
1,2-benzenedicarboxylic acid, di-C6-8-branched alkyl esters, C7-rich	71888-89-6	276-158-1	N.D.	0.05	Toxic for Reproduction
1,2-benzenedicarboxylic acid, di-C7-11-branched and linear alkyl esters	68515-42-4	271-084-6	N.D.	0.05	Toxic for Reproduction
1,2,3-trichloropropane	96-18-4	202-486-1	N.D.	0.05	Carcinogen Toxic for Reproduction
Hydrazine	7803-57-8 302-01-2	206-114-9	N.D.	0.05	Carcinogen
Strontium chromate*	7789-06-2	232-142-6	N.D.	0.005	Carcinogen

\* The measurement is done by the Company subject to the General Conditions of Service which are available on our website at <http://www.sgslab.com>, for which the level of measurement, subject to the General Conditions of Service, is indicated. The results of the analysis are provided to the client for their information only. The results of the analysis are not intended to be used for legal purposes. The results of the analysis are not intended to be used for legal purposes. The results of the analysis are not intended to be used for legal purposes. The results of the analysis are not intended to be used for legal purposes. The results of the analysis are not intended to be used for legal purposes.

Substance Name	CAS number	EC number	Concentration (%)	Reporting Limit (%)	Classification
1,2-Dichloroethane	107-06-2	203-458-1	N.D.	0.05	Carcinogenic
2,2'-dichloro-4,4'-methylenedianiline (MOCA)	101-14-4	202-918-9	N.D.	0.05	Carcinogenic
2-Methoxyaniline o-Anisidine	90-04-0	201-963-1	N.D.	0.05	Carcinogenic
4-(1,1,3,3-tetramethylbutyl) phenol, (4-tert-Octylphenol)	140-66-9	205-426-2	N.D.	0.05	Equivalent level of concern having probable serious effects to the environment
Aluminosilicate Refractory Ceramic Fibres* (RCF)	650-017-00-8 (Index no.)	-	N.D.	0.005	Carcinogenic
Arsenic acid*	7778-39-4	231-901-9	N.D.	0.005	Carcinogenic
Bis(2-methoxyethyl) ether	111-96-6	203-924-4	N.D.	0.05	Toxic for reproduction
Bis(2-methoxyethyl) phthalate	117-82-8	204-212-6-	N.D.	0.05	Toxic for reproduction
Calcium arsenate*	7778-44-1	231-904-5	N.D.	0.005	Carcinogenic
Dichromium tris(chromate)*	24613-89-6	246-356-2	N.D.	0.005	Carcinogenic
Formaldehyde, oligomeric reaction products with aniline (technical MDA)	25214-70-4	500-036-1	N.D.	0.05	Carcinogenic
Lead diazide*	13424-46-9	236-542-1	N.D.	0.005	Toxic for reproduction
Lead dipicrate*	6477-64-1	229-335-2	N.D.	0.005	Toxic for reproduction
Lead styphnate*	15245-44-0	239-290-2	N.D.	0.005	Toxic for reproduction
N,N-dimethylacetamide (DMAC)	127-19-5	204-826-4	N.D.	0.05	Toxic for reproduction
Pentazinc chromate octahydroxide*	49663-84-5	256-418-0	N.D.	0.005	Carcinogenic
Phenolphthalein	77-09-8	201-004-7	N.D.	0.05	Carcinogenic
Potassium hydroxyoctaoxidizincdichromate*	11103-86-9	234-329-8	N.D.	0.005	Carcinogenic
Trilead diarsenate*	3687-31-8	222-979-5	N.D.	0.005	Carcinogenic Toxic for reproduction
Zirconia Aluminosilicate Refractory Ceramic Fibres (Zr-RCF)*	650-017-00-8 (Index no.)	-	N.D.	0.005	Carcinogenic

\* In accordance with the European Union's REACH Regulation, the substances listed in this table are classified as carcinogenic, mutagenic or toxic for reproduction. The classification is based on the results of the tests performed by the European Union's Scientific Committee on Toxicology, Mutagenicity and Reproductive Toxicology (SCVT). The classification is based on the results of the tests performed by the European Union's Scientific Committee on Toxicology, Mutagenicity and Reproductive Toxicology (SCVT). The classification is based on the results of the tests performed by the European Union's Scientific Committee on Toxicology, Mutagenicity and Reproductive Toxicology (SCVT).

Substance Name	CAS number	EC number	Concentration (%)	Reporting Limit (%)	Classification
1,2-bis(2-methoxyethoxy) ethane (TEGDME; triglyme)	112-49-2	203-977-3	N.D.	0.05	Toxic for reproduction
1,2-dimethoxyethane; ethylene glycol dimethyl ether (EGDME)	110-71-4	203-794-9	N.D.	0.05	Toxic for reproduction
Diboron trioxide*	1303-86-2	215-125-8	N.D.	0.005	Toxic for reproduction
Formamide	75-12-7	200-842-0	N.D.	0.05	Toxic for reproduction
Lead(II) bis(methanesulfonate)*	17570-76-2	401-750-5	N.D.	0.005	Toxic for reproduction
TGIC(1,3,5-tris(oxiranyl methyl)-1,3,5-triazine-2,4,6(1H,3H,5H)-trione)	2451-62-9	219-514-3	N.D.	0.05	Mutagenic
β-TGIC(1,3,5-tris((2S and 2R)-2,3-epoxypropyl)-1,3,5-triazine-2,4,6-(1H,3H,5H)-trione)**	59653-74-6	423-400-0	N.D.	0.05	Mutagenic
4,4'-bis(dimethylamino) benzophenone (Michler's ketone)	90-94-8	202-027-5	N.D.	0.05	Carcinogenic
N,N,N',N'-tetramethyl-4,4'-methylenedianiline (Michler's base)	101-61-1	202-959-2	N.D.	0.05	Carcinogenic
[4-[4,4'-bis(dimethylamino) benzhydrylidene]cyclohexa-2,5-dien-1-ylidene] dimethylammonium chloride (C.I. Basic Molet 3)	548-62-9	208-953-6	N.D.	0.05	Carcinogenic
[4-[[4-anilino-1-naphthyl][4-(dimethylamino)phenyl]methylene]cyclohexa-2,5-dien-1-ylidene] dimethylammonium chloride (C.I. Basic Blue 26)	2580-56-5	219-943-6	N.D.	0.05	Carcinogenic
α,α-Bis[4-(dimethylamino) phenyl]-4 (phenylamino) naphthalene-1-methanol (C.I. Solvent Blue 4)	6786-83-0	229-851-8	N.D.	0.05	Carcinogenic
4,4'-bis(dimethylamino)-4''-(methylamino)trityl alcohol	561-41-1	209-218-2	N.D.	0.05	Carcinogenic

\* The substances listed by the Company subject to the General Conditions of 2 months prior to the date of the report are not included in the European Commission's list of substances of concern, subject to 1 year and 5 years General Conditions for the substances of concern. The substances listed by the Company subject to the General Conditions of 2 months prior to the date of the report are not included in the European Commission's list of substances of concern, subject to 1 year and 5 years General Conditions for the substances of concern. The substances listed by the Company subject to the General Conditions of 2 months prior to the date of the report are not included in the European Commission's list of substances of concern, subject to 1 year and 5 years General Conditions for the substances of concern.

Substance Name	CAS number	EC number	Concentration (%)	Reporting Limit (%)	Classification
Bis(pentabromophenyl) ether (DecaBDE)	1163-19-5	214-604-9	N.D.	0.05	PBT vP vB
Pentacosfluorotridecanoic acid	72629-94-8	276-745-2	N.D.	0.05	vP vB
Tricosfluorododecanoic acid	307-55-1	206-203-2	N.D.	0.05	vP vB
Henicosfluoroundecanoic acid	2058-94-8	218-165-4	N.D.	0.05	vP vB
Heptacosfluorotetradecanoic acid	376-06-7	206-803-4	N.D.	0.05	vP vB
4-(1,1,3,3-tetramethylbutyl) phenol, ethoxylated - covering well-defined substances and UVCB substances, polymers and homologues	-	-	N.D.	0.05	Equivalent level of concern - probable serious effects on the environment
4-Nonylphenol, branched and linear - substances with a linear and/or branched alkyl chain with a carbon number of 9 covalently bound in position 4 to phenol, covering also UVCB- and well-defined substances which include any of the individual isomers or a combination thereof	-	-	N.D.	0.05	Equivalent level of concern - probable serious effects on the environment
Diazene-1,2-dicarboxamide (C,C'-azodi(formamide))	123-77-3	204-650-8	N.D.	0.05	Equivalent level of concern - probable serious effects on human health
Cyclohexane-1,2-dicarboxylic anhydride (Hexahydrophthalic anhydride - HHPA)	85-42-7	201-604-9	N.D.	0.05	Equivalent level of concern - probable serious effects on human health

\* The measurement has been by the Company, subject to the General Conditions of Service printed on the back of this report, available on request. The results of this measurement are the property of the Company and are not to be used for any other purpose without the prior written consent of the Company. The scope of the Service is limited to the analysis of the sample as described in the report. The Company is not responsible for the accuracy of the results of the measurement if the sample is not representative of the material to be tested. The results of the measurement are not to be used for any other purpose without the prior written consent of the Company. The results of the measurement are not to be used for any other purpose without the prior written consent of the Company. The results of the measurement are not to be used for any other purpose without the prior written consent of the Company.



Substance Name	CAS number	EC number	Concentration (%)	Reporting Limit (%)	Classification
Hexahydromethylphthalic anhydride, Hexahydro-4-methylphthalic anhydride, Hexahydro-1-methylphthalic anhydride, Hexahydro-3-methylphthalic anhydride	25550-51-0, 19438-60-9, 48122-14-1, 57110-29-9	247-094-1, 243-072-0, 256-356-4, 260-566-1	N.D.	0.05	Equivalent level of concern - probable serious effects on human health
Methoxy acetic acid	625-45-6	210-894-6	N.D.	0.05	Toxic for reproduction equivalent level of concern -probable serious effects on human health and the environment
1,2-Benzenedicarboxylic acid, dipentylester, branched and linear	84777-06-0	284-032-2	N.D.	0.05	Toxic for reproduction
Diisopentylphthalate (DIPP)	605-50-5	210-088-4	N.D.	0.05	Toxic for reproduction
N-pentyl-isopentylphthalate	-	-	N.D.	0.05	Toxic for reproduction
1,2-Diethoxyethane	629-14-1	211-076-1	N.D.	0.05	Toxic for reproduction
N,N-dimethylformamide; dimethyl formamide	68-12-2	200-679-5	N.D.	0.05	Toxic for reproduction
Dibutyltin dichloride (DBT)	683-18-1	211-670-0	N.D.	0.05	Toxic for reproduction
Acetic acid, lead salt, basic*	51404-69-4	257-175-3	N.D.	0.005	Toxic for reproduction
Basic lead carbonate (trilead bis(carbonate)dihydroxide)*	1319-46-6	215-290-6	0.0081	0.005	Toxic for reproduction
Lead oxide sulfate (basic lead sulfate)*	12036-76-9	234-853-7	0.0083	0.005	Toxic for reproduction
[Phthalato(2-)]dioxotrilead (dibasic lead phthalate)*	69011-06-9	273-688-5	0.0086	0.005	Toxic for reproduction

\* The substances listed by the Company subject to the General Conditions of Service unless stated, available on internet are made of <http://www.sgs.com> or <http://www.cas.org>. In addition, based on internet, subject to the General Conditions of Service, the substances listed by the Company subject to the General Conditions of Service unless stated, available on internet are made of <http://www.sgs.com> or <http://www.cas.org>. In addition, based on internet, subject to the General Conditions of Service, the substances listed by the Company subject to the General Conditions of Service unless stated, available on internet are made of <http://www.sgs.com> or <http://www.cas.org>. In addition, based on internet, subject to the General Conditions of Service, the substances listed by the Company subject to the General Conditions of Service unless stated, available on internet are made of <http://www.sgs.com> or <http://www.cas.org>.

Substance Name	CAS number	EC number	Concentration (%)	Reporting Limit (%)	Classification
Dioxobis(stearato)trilead*	12578-12-0	235-702-8	0.0128	0.005	Toxic for reproduction
Fatty acids, C16-18, lead salts*	91031-62-8	292-966-7	0.0243	0.005	Toxic for reproduction
Lead bis(tetrafluoroborate)*	13814-96-5	237-486-0	0.012	0.005	Toxic for reproduction
Lead cyanamidate*	20837-86-9	244-073-9	0.0078	0.005	Toxic for reproduction
Lead dinitrate*	10099-74-8	233-245-9	0.0104	0.005	Toxic for reproduction
Lead oxide (lead monoxide)*	1317-36-8	215-267-0	0.0070	0.005	Toxic for reproduction
Lead tetroxide (orange lead)*	1314-41-6	215-235-6	0.0072	0.005	Toxic for reproduction
Lead titanium trioxide*	12060-00-3	235-038-9	0.0095	0.005	Toxic for reproduction
Lead Titanium Zirconium Oxide*	12626-81-2	235-727-4	N.D.	0.005	Toxic for reproduction
Pentalead tetraoxide sulphate*	12065-90-6	235-067-7	0.0075	0.005	Toxic for reproduction
Pyrochlore, antimony lead yellow*	8012-00-8	232-382-1	N.D.	0.005	Toxic for reproduction
Silicic acid, barium salt, lead-doped*	68784-75-8	272-271-5	N.D.	0.005	Toxic for reproduction
Silicic acid, lead salt*	11120-22-2	234-363-3	0.0089	0.005	Toxic for reproduction
Sulfurous acid, lead salt, dibasic*	62229-08-7	263-467-1	0.0083	0.005	Toxic for reproduction
Tetraethyllead*	78-00-2	201-075-4	N.D.	0.005	Toxic for reproduction
Tetralead trioxide sulphate*	12202-17-4	235-380-9	0.0076	0.005	Toxic for reproduction

\* The substances listed by the Company, subject to the General Conditions of Service printed or attached, which are available at [www.sgs.com](http://www.sgs.com), are checked against the current list of substances subject to the General Conditions of Service. The Company is not responsible for the accuracy of the information provided in this report. The Company is not responsible for the accuracy of the information provided in this report. The Company is not responsible for the accuracy of the information provided in this report. The Company is not responsible for the accuracy of the information provided in this report.

Substance Name	CAS number	EC number	Concentration (%)	Reporting Limit (%)	Classification
Trilead dioxide phosphonate*	12141-20-7	235-252-2	N.D.	0.005	Toxic for reproduction
Furan	110-00-9	203-727-3	N.D.	0.05	Carcinogenic
Propylene oxide; 1,2-epoxypropane; methyloxirane	75-56-9	200-879-2	N.D.	0.05	Carcinogenic Mutagenic
Diethyl sulphate	64-67-5	200-589-6	N.D.	0.05	Carcinogenic Mutagenic
Dimethyl sulphate	77-78-1	201-058-1	N.D.	0.05	Carcinogenic
3-ethyl-2-methyl-2-(3-methylbutyl)-1,3-oxazolidine	143860-04-2	421-150-7	N.D.	0.05	Toxic for reproduction
Dinoseb	88-85-7	201-861-7	N.D.	0.05	Toxic for reproduction
4,4'-methylenedi-o-toluidine	838-88-0	212-658-8	N.D.	0.05	Carcinogenic
4,4'-oxydianiline and its salts	101-80-4	202-977-0	N.D.	0.05	Carcinogenic Mutagenic
4-Aminoazobenzene; 4-Phenylazoaniline	60-09-3	200-453-6	N.D.	0.05	Carcinogenic
4-methyl-m-phenylenediamine (2,4-toluene-diamine)	95-80-7	202-453-1	N.D.	0.05	Carcinogenic
6-methoxy-m-toluidine (p-cresidine)	120-71-8	204-419-1	N.D.	0.05	Carcinogenic
Biphenyl-4-ylamine	92-67-1	202-177-1	N.D.	0.05	Carcinogenic
o-aminoazotoluene	97-56-3	202-591-2	N.D.	0.05	Carcinogenic
o-Toluidine; 2-Aminotoluene	95-53-4	202-429-0	N.D.	0.05	Carcinogenic
N-methylacetamide	79-16-3	201-182-6	N.D.	0.05	Toxic for reproduction
1-bromopropane; n-propyl bromide	106-94-5	203-445-0	N.D.	0.05	Toxic for reproduction

\* The measurement is done by the Company subject to the General Conditions of Service published on the website of [www.samsungled.com](http://www.samsungled.com), or the website of the Client, subject to the General Conditions of Service published on the website of the Client. The Company is not responsible for the results of the analysis if the Client does not provide the necessary information or if the Client does not follow the instructions of the Company. The Company is not responsible for the results of the analysis if the Client does not provide the necessary information or if the Client does not follow the instructions of the Company. The Company is not responsible for the results of the analysis if the Client does not provide the necessary information or if the Client does not follow the instructions of the Company.









Revision History
------------------

Date	No.	Revision History	Writer	
			Drawn	Approved
2013. 11. 07	01	New Version	W.H Jung	S.B Yun