

## ASR002 Smart SPI TMR Angle Sensor

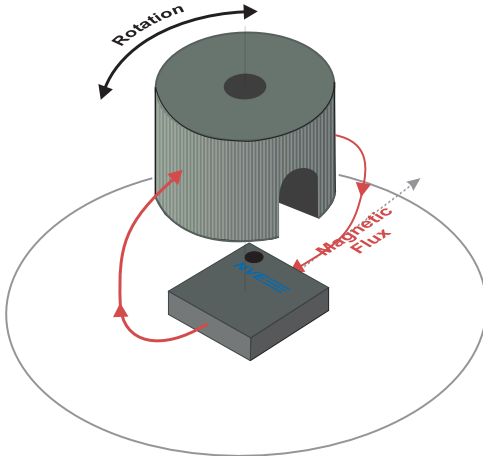

### Features

- Rotational speeds to 375,000 RPM
- 3.3 volt or 5 volt compatible four-wire SPI interface
- Robust airgap and misalignment tolerances
- Factory calibrated
- Ultraminiature 2.5 x 2.5 x 0.8 mm TDFN6 package

### Key Specifications

- 0.1° resolution
- ±0.2° repeatability
- Robust 6 to 20 mT (60 to 200 Oe) field operating range
- Fast 12.5 kSps sample rate
- Flexible 2.2 to 3.6 V supply range
- Low 4 mA typical supply current
- Full -40 °C to 125 °C operating range

### Applications

- Rotary encoders
- Robotics
- Motor control
- Automotive applications
- Internet of Things (IoT) end nodes

### Description

ASR002 TMR Smart Angle Sensors provide a precise digital angle measurement over a wide range of speeds.

The sensor combines precise, low-power Tunneling Magnetoresistance (TMR) sensing elements with sophisticated digital signal processing.

The sensor is factory calibrated, with coefficients stored in internal memory.

A four-wire SPI interface provides angle data and allows setting device parameters.

The ASR002 is designed for harsh industrial or automotive environments with ESD protection, and full -40 °C to 125 °C operating temperature range.

### Block Diagram

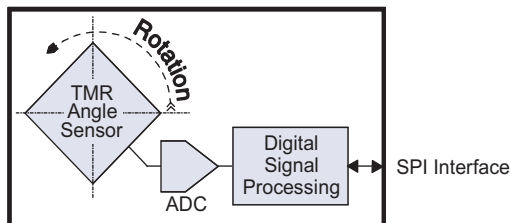

### Transfer Function

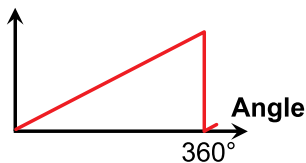

## Boundary Ratings

---

Parameter	Min.	Max.	Units
Supply voltage	-12	4.2	Volts
Input and output voltages (MISO, MOSI, SS, SCLK)	-0.5	$V_{cc}+2.5$ up to 5.8	Volts
Input current	-100	+100	mA
Storage temperature	-55	150	°C
ESD (Human Body Model)		2000	Volts
Applied magnetic field		Unlimited	Tesla

## Operating Specifications ( $T_{min}$ to $T_{max}$ : $2.2 < V_{DD} < 3.6$ V unless otherwise stated)

Parameter	Symbol	Min.	Typ.	Max.	Units	Test Condition
Operating temperature	$T_{min}; T_{max}$	-40		125	°C	
Supply voltage	$V_{DD}$	2.2		3.6	V	
Supply current	$I_{DD}$		4	6	mA	Max. at $V_{DD} = 3.6$ V
Power-on Reset supply voltage	$V_{POR}$		1.4		V	
Brown-out power supply voltage	$V_{BOR}$	0.75	1	1.36	V	
Start-up time	$T_{STA}$		15		ms	
<b>Magnetics</b>						
Applied magnetic field strength	H	6	12	20	mT	
		60	120	200	Oe	
<b>Accuracy and Repeatability</b>						
Angular resolution	$\delta$		0.1		Angular Degrees	Fixed temperature and bias <sup>1</sup>
Angular hysteresis	$\square$			0.1		
Repeatability			$\pm 0.2$			
Angular accuracy, fixed bias <sup>1</sup>	$\epsilon$			$\pm 2$		
Angular accuracy, variable bias <sup>2</sup>				$\pm 3$		
				$\pm 6$		-40 to 125°C
<b>Speed</b>						
Sample rate			12.5		kSps	
<b>SPI Bus Characteristics</b>						
Bus voltage	$V_{BUS}$	2.2		5.5	V	
Low level input threshold voltage	$V_{IL}$	0.8			V	
High level input threshold voltage	$V_{IH}$			2.2	V	
Low level output current	$I_{OL}$	3			mA	$V_{OL} = 0.4$ V
I/O capacitance	$C_{I/O}$			10	pF	
<b>SPI Setup and Hold Timing</b>						
Data transfer rate	DR			2	Mbits/s	Full duplex
SCLK Rise time	$t_R$				ns	See figure 7
SCLK fall time	$t_F$				ns	
SCLK low time	$t_{CL}$	200			ns	
SCLK fall time	$t_{CH}$	200			ns	
SS to SCLK setup	$t_{SE}$	80			ns	
SCLK to MISO valid	$t_{SDD}$			170	ns	
SS to MISO tri-state	$t_{SDZ}$			170	ns	
SCLK to MOSI hold time	$t_{SDH}$	80			ns	
MOSI to SCLK setup	$t_{SDS}$	80			ns	
SCLK to SS hold time	$t_{SH}$	80			ns	
SS to MISO valid	$t_{SEZ}$			170	ns	
<b>RAM Timing</b>						
Address setup time	$t_{ADDR}$	3			$\mu$ s	See figure 4
Data read time	$t_{READ}$	10			$\mu$ s	
<b>Nonvolatile Memory Characteristics</b>						
Address setup time	$t_{ADDR}$	3			$\mu$ s	See figure 5
Data read time	$t_{READ}$	10			$\mu$ s	
Data write time	$t_{NVM}$	20			ms	
Endurance			10000		Cycles	
<b>Package Thermal Characteristics</b>						
Junction-to-ambient thermal resistance	$\theta_{JA}$		320		°C/W	
Package power dissipation			500		mW	

### Specification Notes:

1. “Fixed Bias” means a fixed airgap within between the bias magnet and sensor so the magnitude of the magnetic field at the sensor is constant within the specified field range of the parts. The highest accuracy is obtained using fields closest to the 17.5 mT (175 Oe) factory calibration field.
2. “Variable Bias” means the magnitude of the magnetic field at the sensor can vary across the entire specification range.

**ASR002 Overview**

The ASR002 is a non-contact angle sensor designed for high speed applications where size is limited. The heart of the ASR002 is a tunneling magnetoresistive (TMR) sensor. In a typical configuration, an external magnet provides a magnetic field of 6 to 20 mT (60 to 200 Oe) in the plane of the sensor, as illustrated below for a bar magnet and a diametrically-magnetized disk magnet. Factory-programmed signal conditioning is combined with a temperature sensor and digital linearization to produce high speed, accuracy, and precision in a tiny 2.5 x 2.5 mm TDFN package.

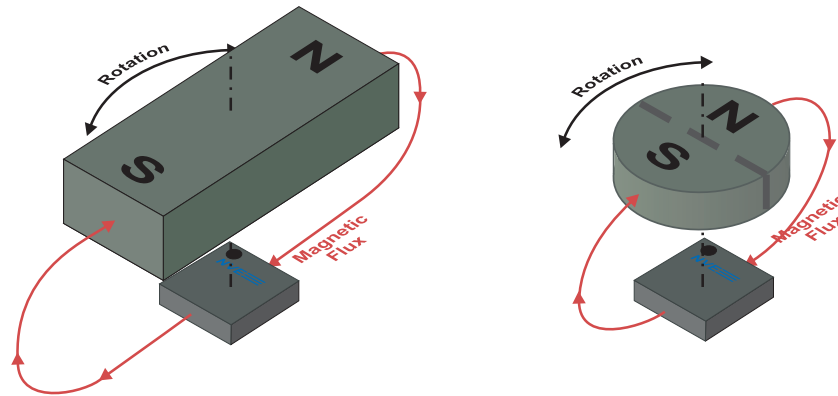

**Figure 1. Sensor operation.**

**ASR002 Operation**

A detailed block diagram is shown below:

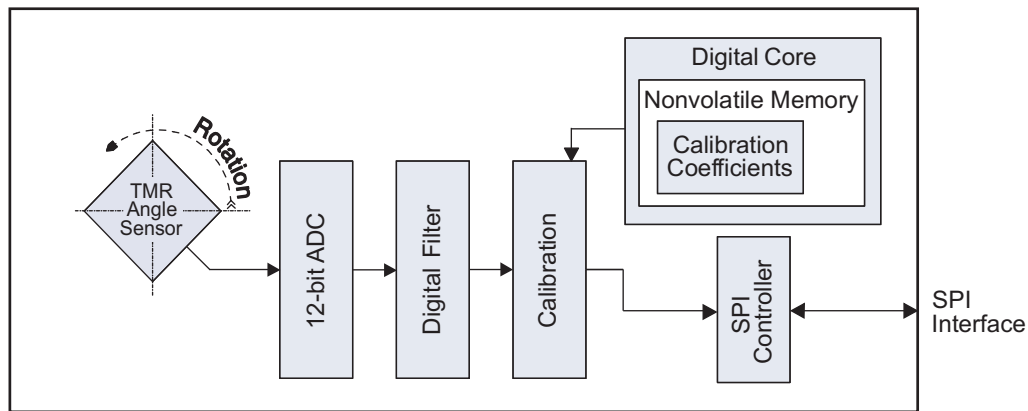

**Figure 2. Detailed block diagram.**

**TMR Angle Sensor Element**

ASR002 sensors use unique TMR sensor elements that are inherently high speed and low noise. The digital core calculates the angle from sensor element Sine and Cosine vectors, and the raw sensor data are available from separate memory locations.

**ADC**

The sensor output is digitized with a 12-bit ADC. The extra bits ensure precision and computational accuracy.

**Digital Filter**

A first-order Infinite Impulse Response (IIR) digital filter with a programmable cutoff frequency can be used for ultralow noise if high-frequency operation is required. The factory default is the filter turned off.

### Rotation Direction

The ASR002 can provide increasing angle values for either clockwise or counterclockwise field rotations. Counterclockwise is defined as a rotating field vector through pins 1-3-4-6, and clockwise through pins 1-6-4-3. The rotation direction can be programmed using the  $\theta_{DIR}$  parameter.

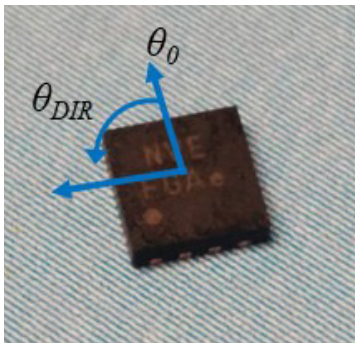

Figure 3. Zero-angle reference ( $\theta_0$ ) and rotation direction ( $\theta_{DIR}$ ). The rotational center of the sensor is the package center.

### Zero-Angle Reference Point

A programmable parameter  $\theta_0$  sets the zero-degree reference or angular offset. This is the angle of “discontinuity,” that is, where the angle output changes from 360° to 0°. The default  $\theta_0$  value is zero for magnetic fields pointing from pin 1 to pin 6.

### Direction and Hysteresis

The Direction output indicates direction of rotation. A hysteresis setting can be changed to prevent small changes from causing the Direction output to “chatter,” especially at low speed.

### Digital Filter

The digital filter is an Infinite impulse response (IIR) weighted running average filter, which can reduce mechanical and electrical noise depending on the required speed.

The filtered output is calculated as follows:

$$\theta_n = \theta/m + [(m-1)/m]\theta_{n-1}$$

Where  $\theta$  = is the measured angle;  $\theta_n$  = the filtered angle;  $\theta_{n-1}$  is the previous value of the filtered angle; and  $m$  is a constant that determines the cutoff frequency as follows:

$$f_{CUTOFF} = f_{SAMPLE}/(2\pi m)$$

Where  $f_{CUTOFF}$  is the filter cutoff frequency and  $f_{SAMPLE}$  is the sensor ADC sampling rate (approximately 12500/s). So for example, if  $m = 10$ , the cutoff frequency is approximately 200 Hz.

$m = 1$  disables filter so the output is simply updated with each sample.

### A Simple SPI Interface

The SPI interface is an industry standard four-wire, full-duplex 2 megabit per second connection with the sensor as the slave to an external master such as a microcontroller. SPI data (MOSI and MISO) and the Clock (SCLK) are 2.2 volt to five-volt compliant. The digital angle is the default two byte response.

The ASR002 uses an industry-standard “Mode 0” interface (data is sampled at the leading rising edge of the clock; CPOL=0 and CPHA=0). In accordance with industry standards, slave select (SS) is active-low, and bit order and byte order are from MSB to LSB.

Details are shown in the following timing diagrams:

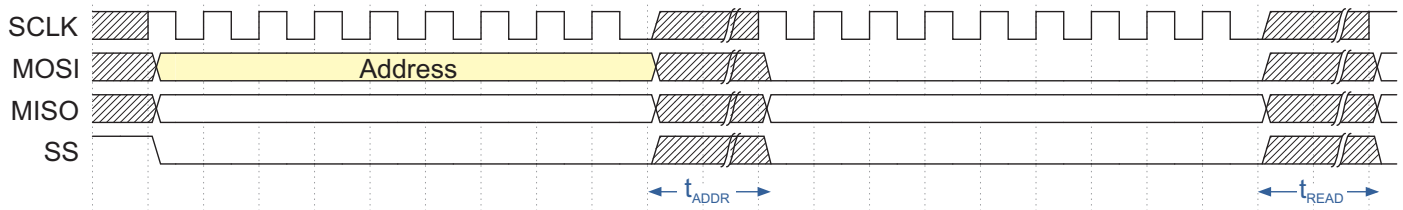

Figure 4a. Sending the address for a read.

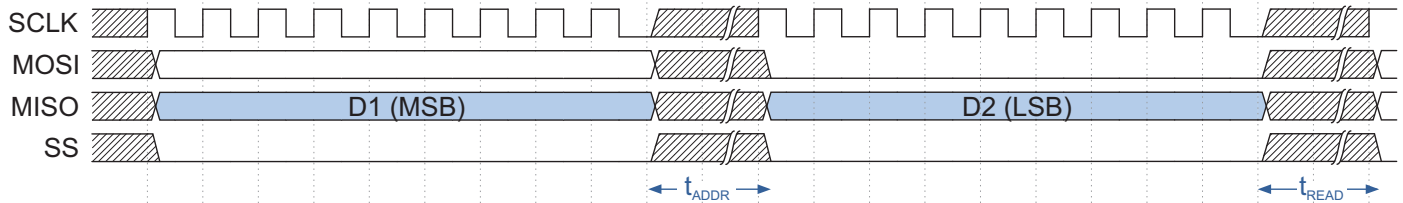

Figure 4b. Reading data.

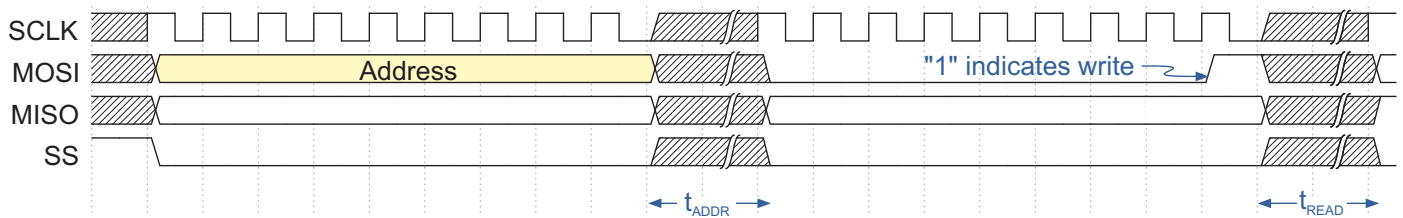

Figure 5a. Sending the address for a write.

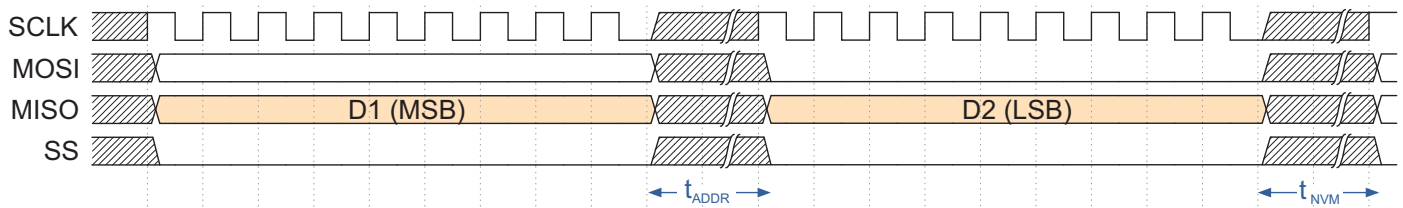

Figure 5b. Writing data.

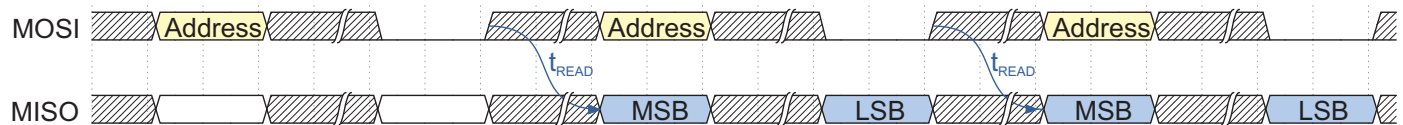

Figure 6. Continuous read.

SPI setup and hold timing constraints are shown in Figure 7:

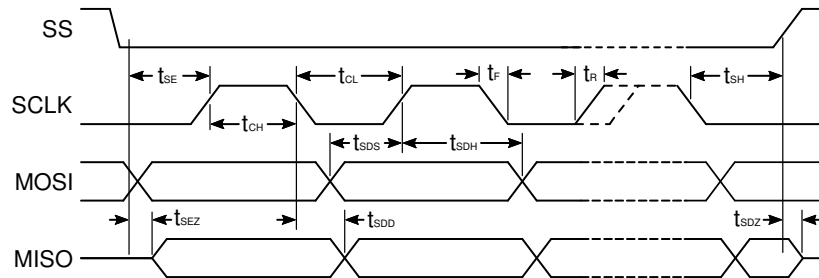

Figure 7. SPI setup and hold timing.

A schematic of a typical interface to a 3.3-volt or five-volt microcontroller is shown in Figure 10.

### **Straightforward Reading and Writing**

The sensor is reset on a falling edge of SS. All reads and writes are initiated by the master pulling SS “LOW” and sending an eight-bit address to the ASR002 plus a second byte. The least significant bit of the second address byte indicates whether the address request is for a read or a write (“0” is a read; “1” is a write). The slave responds with two bytes of data.

As shown in figures 4 and 5, and the specification table, a 3  $\mu$ s delay ( $t_{ADDR}$ ) is needed between address bytes; 10  $\mu$ s ( $t_{READ}$ ) should be allowed before data can be read, and 20 ms ( $t_{NVM}$ ) should be allowed for writing parameters to the nonvolatile memory.

### ***Reading the angle***

To read the angle, the master simply writes two zero bytes for the “0” angle address, then reads the two-byte angle, which is expressed in tenths of degrees. These two-byte reads can be repeated to continuously read the angle as shown in the Figure 6 timing diagram and the code on p. 14.

### ***Reading and writing parameters***

Reading and writing parameters are simple four-byte sequences. The master writes two bytes for the parameter address, then reads or writes two bytes for the parameter value. Illustrative code to zero the sensor by writing the offset parameter is shown on p. 15.

The number of bits in different parameters varies. Unused bits are sent as zeros by the sensor. Similarly, unused bits should be written as zeros to the sensor to avoid an out-of-range parameter that could be ignored.

Because of the slower speed of the sensor’s nonvolatile memory, allow 15 ms for parameter writes.



## Memory Map

The ASR002 memory provides access to angle data and user-programmable parameters. The memory is accessed via SPI as described in the SPI interface section.

Parameter	Symbol	Default	Read/Write	Range	Address	Description
<b>Data</b>						
Angle	$\theta$	N/A	R	0 – 3600	0x00	In tenths of a degree
Raw Sin Vector	Sin $\theta$			Approx. 1500 – 2500	0x01	Raw outputs centered at approx. 2048 with peak-peak amplitudes of approx. 1000.
Raw Cos Vector	Cos $\theta$				0x02	
Direction	Dir			0 – 1	0x03	0 = decreasing angle 1 = increasing angle
<b>User-Programmable Parameters</b>						
Rotation Direction	$\theta_{DIR}$	0	R/W	0 – 1	0x40 [bit 0]	0 → increasing CCW; 1 → increasing CW (see Fig. 3)
Angular Offset	$\theta_0$	0		0 – 3600	0x41 [bits 13:0]	Point at which angle is zero (see Fig. 3)
Digital Filter Constant	m	1		1 – 255	0x42	$f_{CUTOFF} = f_{SAMPLE} / (2\pi m)$ ; $f_{SAMPLE} = \text{approx. } 12.5 \text{ kSps}$ m = 1 disables filter
Direction Hysteresis	$\delta_{DIR}$	25		0 – 255 (0 – 25.5°)	0x43	Hysteresis of the “Dir” output; in tenths of a degree
<b>Read-Only Memory</b>						
Lot code	YY	N/A	R	N/A (ASCII)	0x80	ASCII date code in the form YYWWXX, where: YY = year; WW = work week; XX = internal code.
	WW				0x81	
	XX				0x82	

**Table 1. ASR002 Memory Locations.**

### **Power-Up and Initialization**

---

#### ***Absolute position***

Unlike some encoder types, ASR002 sensors detect absolute position and maintain position information when the power is removed. The sensor powers up indicating the correct position.

#### ***Nonvolatile parameters***

All parameters are nonvolatile so they can be set once (via SPI), and remain for the life of the product if desired.

### **Minimizing Noise**

---

Several steps minimize noise:

- A 10  $\mu$ F bypass capacitor is recommended as close as possible to the  $V_{DD}$  and GND pins. A 0.080 x 0.050 inch or smaller capacitor is recommended to minimize magnetic interference with the sensor.
- Use a circuit board ground plane.
- Grounding the sensor's center pad allows the leadframe to act as a shield.

**Magnet Selection**

The sensor’s wide operating field range of 6 to 20 mT (60 to 200 Oe) allows inexpensive magnets and operation over a wide range of magnet spacing. The figures below show the magnetic field for various magnet geometries and distances for inexpensive C5/Y25 grade ferrite magnets:

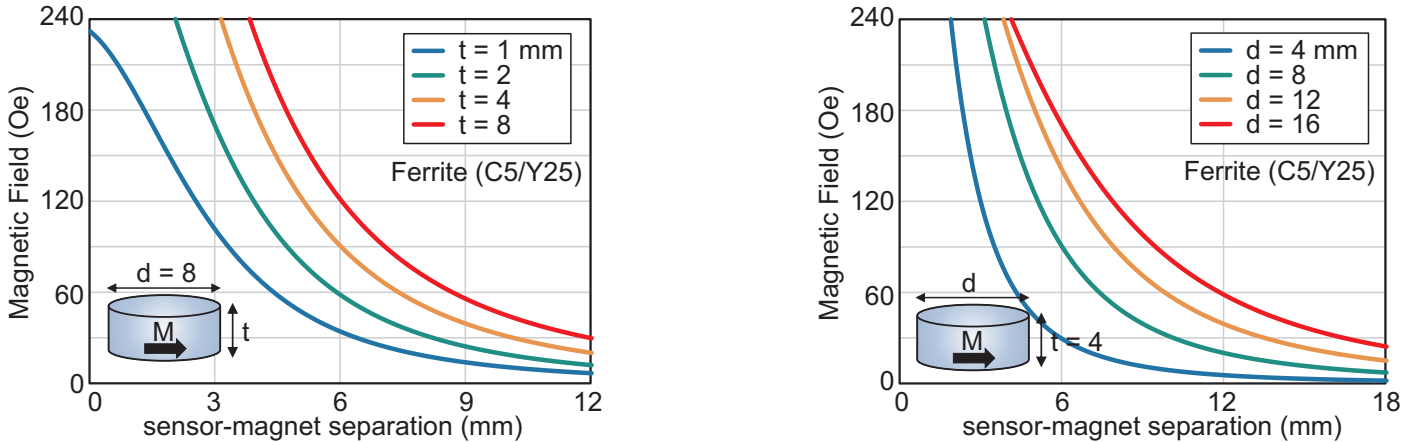

**Figure 8. Magnetic fields for various geometries of C5/Y25 ferrite magnets plotted for the distance between the magnet and sensor. Eight-millimeter diameter magnets of various thicknesses are shown at left, and four-millimeter thick magnets of various diameters are shown at right.**

Field varies less with distance for larger magnets, so maximizing magnet size within the mechanical constraints of the system maximizes accuracy.

Higher-grade magnets can be used for high-temperature applications or large magnet-sensor separations. The graph below shows field strengths with various materials:

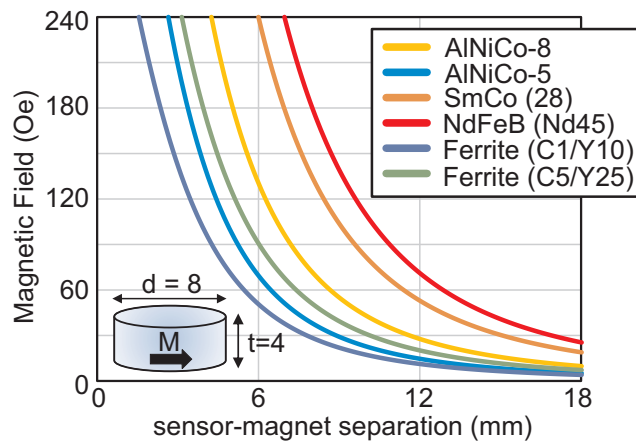

**Figure 9. Magnetic fields from an 8 millimeter diameter, 4 millimeter thick magnet for increasing magnet-sensor separation. NdFeB materials produce the largest magnetic fields and separations. SmCo and AlNiCo materials offer the highest operating temperatures. Ferrite magnets are the most cost-effective.**

Our free Web app can be used to determine optimum separations for various magnet sizes and materials:

<https://www.nve.com/spec/calculators.php>.

[NVE’s Online Store](#) stocks popular magnets.

**Application Circuits**

**Typical Microcontrollers Interface**

A typical microcontroller interface is shown below:

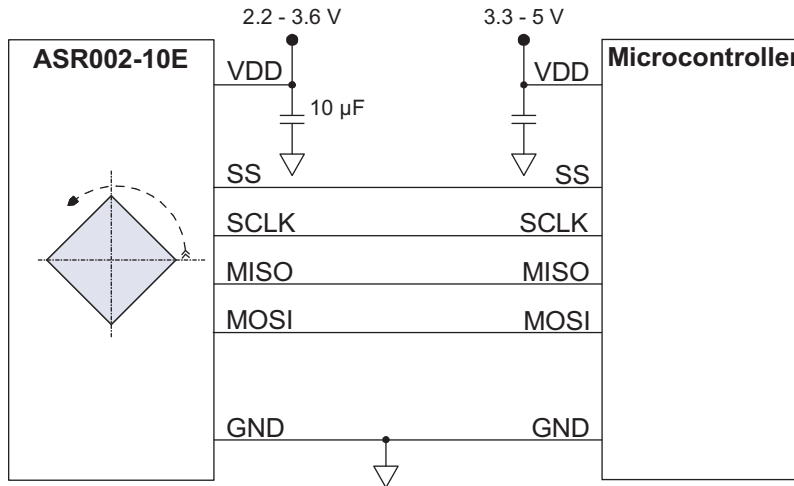

**Figure 10. Typical microcontroller interface.**

The ASR002 is configured as a Slave and the microcontroller should be configured as the Master. The ASR002 SPI interface is compatible with 3.3 or five-volt microcontrollers.

### Typical Read and Write Communications Pseudocode

```

//SPI clock set elsewhere (2 MHz max.)
//SPSR = SPI Status Register; SPIF = SPI Status Register Interrupt flag
//SS set low (active) elsewhere
{
    case COMM_GET_MEM:           //Routine to READ memory
    SPDR=buffer[1];              //Sends the address to read from
    while(! (SPSR & (1<<SPIF))); //Waits for transmission
    _delay_us(3);                //Allow 3 microseconds between address bytes

    SPDR=0x00;                   //'0' for second address byte (indicates read)
    while(! (SPSR & (1<<SPIF))); //Waits for transmission
    _delay_us(10);               //Allows 10 microseconds for the address to be sent

    SPDR=0x00;                   //Waits for transmission to complete
    while(! (SPSR & (1<<SPIF))); //Allows 10 microseconds for data to be sent
    _delay_us(10);
    MSB=SPDR;                    //Reads the first byte of data (MSB)

    SPDR=0x00;                   //Waits for transmission to complete
    while(! (SPSR & (1<<SPIF))); //Allows 10 microseconds for data to be sent
    _delay_us(10);
    LSB=SPDR;                    //Reads the second byte of data (LSB)

    buffer[0]=MSB;               //Stores data in the buffer
    buffer[1]=LSB;

    *output_len=2;               //Number of bytes to transmit
    break;

    case COMM_SET_MEM:           //WRITE memory routine (to set sensor parameters)
    SPDR=buffer[1];              //Puts the address to read from in the buffer
    while(! (SPSR & (1<<SPIF))); //Wait for transmission to be complete
    _delay_us(3);                //Allow address byte to be sent

    SPDR=0x01;                   //'1' for second address byte (write bit)
    while(! (SPSR & (1<<SPIF))); //Wait for transmission to complete
    _delay_us(10);               //Allows time for data to be sent

    SPDR=buffer[2];              //Read first data byte(MSB)
    while(! (SPSR & (1<<SPIF))); //Allows time for the data to be sent
    _delay_us(10);

    SPDR=buffer[3];              //Read second data byte(LSB)
    while(! (SPSR & (1<<SPIF))); //Allows 20 MILLIseconds to write to nonvolatile memory
    _delay_ms(20);

    break;
}

```

## Illustrative Arduino Code for Continuous Read

---

```

/*****
Continuously read the angle from an NVE ASR002 Smart Angle Sensor
Arduino Uno connections: pin 10=SS; pin 11=MOSI; pin 12=MISO; pin 13=SCLK
*****/

#include <SPI.h>
int angle;

void setup() {
  pinMode(10, OUTPUT); //Pin 10 = Sensor SS
  SPI.begin ();

  //Set clock rate at 2 Mbits/s; MSB first; Mode 0
  SPI.beginTransaction(SPISettings(2000000, MSBFIRST, SPI_MODE0));
  digitalWrite(CS, HIGH); //Disable to reset the sensor
  digitalWrite(10, LOW); //Re-enable sensor
}

void loop() {
  angle = (SPI.transfer (0))<<8; //Send 0 for address angle; receive angle MSB
  delayMicroseconds (3); //Allow 3 us between address bytes
  angle |= SPI.transfer (0); //2nd address byte (0 for read); receive angle LSB
  delayMicroseconds (10); //Allow 10 us for next data
}

```

### Illustrative Arduino Code to Zero the Sensor

```

/*****
Zeros an ASR002 at its current location to establish a "home position."
Arduino Uno connections: pin 11=MOSI; pin 12=MISO; pin 13=SCLK; pins 9 & 10=SS
Includes a simple procedure to read the angle.
*****/
#include <SPI.h>
int angle;

void setup() {
pinMode(10, OUTPUT); //Pin 10 = Sensor SS
SPI.begin ();

//Set clock rate to 2 Mbits/s; MSB first; Mode 0
SPI.beginTransaction(SPISettings(2000000, MSBFIRST, SPI_MODE0));
digitalWrite(10, HIGH); //Disable to reset the sensor
digitalWrite(10, LOW); //Re-enable sensor

//Read starting angle
SPI.transfer (0); //Send 0 for address angle to read starting angle
delayMicroseconds (3); //Allow 3 us between address bytes
angle = (SPI.transfer (0x41))<<8; Read starting angle MSB and point to offset address
delayMicroseconds (3); //Allow 3 us between address bytes
angle |= SPI.transfer (1); //Read angle LSB; 2nd address byte = 1 for write
delayMicroseconds (10); //Allow 10 us for next data

//Reset offset
SPI.transfer (0); //Write offset MSB
delayMicroseconds (3); //Allow time between bytes
SPI.transfer (0); //Write offset LSB
delay (20); //20 ms NVM delay

//Write measured angle to offset parameter to zero the sensor
angle=getAngle(); //Read angle now that offset has been set to zero
SPI.transfer (0x41); //Point to offset address
delayMicroseconds (3); //Allow time between address bytes
SPI.transfer (1); //2nd address byte = 1 for write
delayMicroseconds (10);
SPI.transfer (0x41); //Write to offset parameter to zero the sensor
delayMicroseconds (3);
SPI.transfer (angle & 0xFF); //Write LSB
delay (20); //20 ms NVM delay
}

void loop() {}

//Procedure to read the angle
int getAngle(){
int angle;
angle = (SPI.transfer (0))<<8; //Send 0 for address angle; receive angle MSB
delayMicroseconds (3); //Allow 3 us between address bytes
angle |= SPI.transfer (0); //2nd address byte (0 for read); receive angle LSB
delayMicroseconds (10); //Allow 10 us for next data
return angle;
}

```

### In Case of Difficulty

---

#### Random data, or measured angles outside the allowable 0 to 3600 range.

- The SPI clock may be too fast (the ASR002 maximum clock rate is specified as 2 Mbits/s).
- Ensure the Master is operating in the correct mode (Mode 0).

#### Random data, or measured angles outside the allowable 0 to 3600 range on the first readings after the sensor is selected.

- The sensor is reset on a falling edge of SS. Toggling SS HIGH, then LOW will ensure the sensor is reset.

#### MSB/LSB bytes are reversed.

- The MSB should be read first. SPI devices use different byte orders, but the ASR002 follows the most common convention of MSB first.

#### Angle data is shifted by one or more bits.

- This is usually because the sensor has not completed internal shifting of bits into the correct positions. Ensure there is enough settling time between writing the address and reading the data (10  $\mu$ s minimum).

#### Garbled data on first startup of Master.

- Data can be left in the sensor if the Master microcontroller is reset and the sensor is not. This can be corrected by doing a “dummy read” as part of the microcontroller startup sequence, or toggling SS HIGH then LOW to reset the sensor.

#### Parameters do not appear to be written correctly.

- Ensure that the Write bit is set in the second (LSB), i.e., the second address byte is a “1.”
- Ensure there is adequate settling time before reading or using a written parameter (10 milliseconds minimum). Parameters are stored in nonvolatile memory, not RAM, and writing to nonvolatile memory is much slower.



## Evaluation Support

### Breakout Board

The AG957-07E breakout board provides easy connections to an ASR002-10E angle sensor with a six pin connector. It also has a recommended 10  $\mu$ F bypass capacitor:

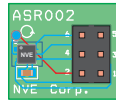

**Figure 11. AG957-07E breakout board (actual size)**  
0.5" x 0.6" (12 mm x 15 mm)

### Smart Angle Sensor Evaluation Kit

This simple board includes an ASR002-10E Smart Angle Sensor, a microcontroller that interfaces to the Sensor via SPI, and to a PC via USB. The kit includes a diametrically-magnetized cylindrical horseshoe magnet and fixturing. A PC-based user interface provides two-way communication with the sensor to display the sensor outputs and change the sensor's parameters.

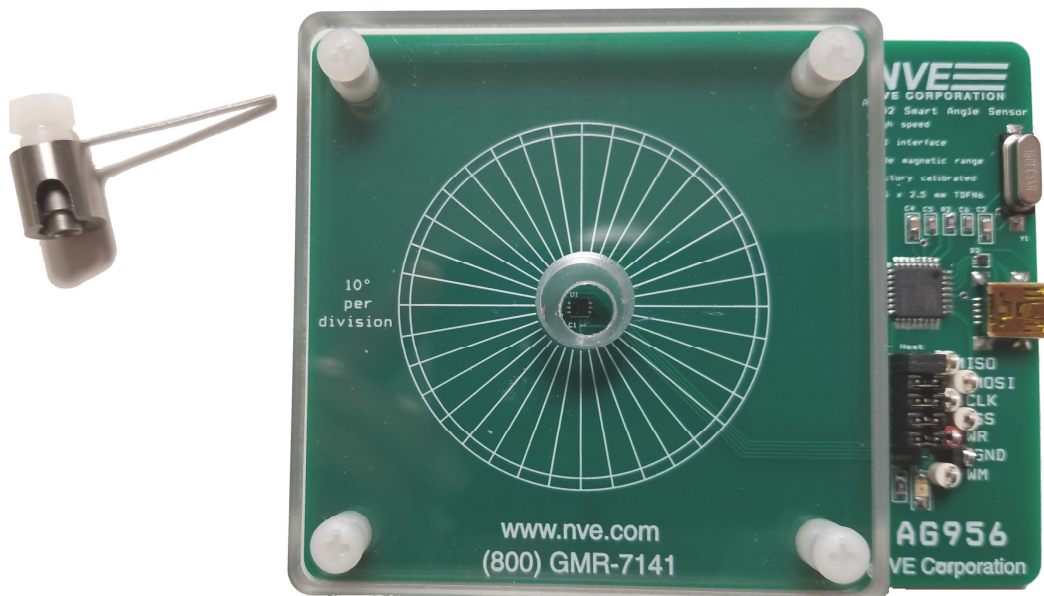

**Figure 12. AG956-07E: Smart Angle Sensor Evaluation Kit.**

### Socket Board

The AG954-07E provides a TDFN6 socket for easy interface to sensors such as the ASR002-10E without soldering:

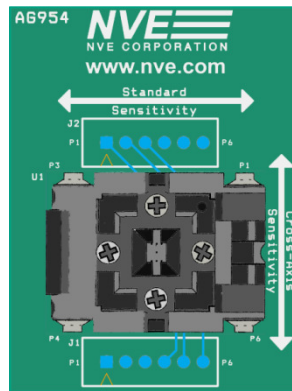

**Figure 13. AG954-07E: TDFN socket board**  
1.5" x 2" (38 mm x 50 mm)(actual size)

## Magnets

NVE stocks five popular magnets for use with its angle sensors:

NVE Part Number	Compatible Magnet Holder	Diameter (mm)	Length (mm)	Typ. sensor distance (mm; 12 mT/120 Oe nom. field)	Material and Configuration
12526	4 mm	4	4	3	C5/Y25 ferrite disk magnets
12249	N/A	12.5	3.5	4	
12527	8 mm	8	4	5	
12528	8 mm	8	8	6	
12426*	N/A	11	11	8	Alnico-5 round horseshoe magnet with mounting hole

\*Included in the AG956-07E Smart Angle Sensor Evaluation Kit.

**Table 2. Popular magnets for angle sensing.**

## Magnet Holders

NVE offers two magnet holders for evaluation and prototyping. The holders are machined aluminum. Set screws secure the magnets in the holders and allow magnet position adjustments. There are threaded mounting holes for a thumbscrew to turn the magnet, or the hole can be used to attach the holder to a rotating shaft. A “clockhand” indicator helps track magnet rotation:

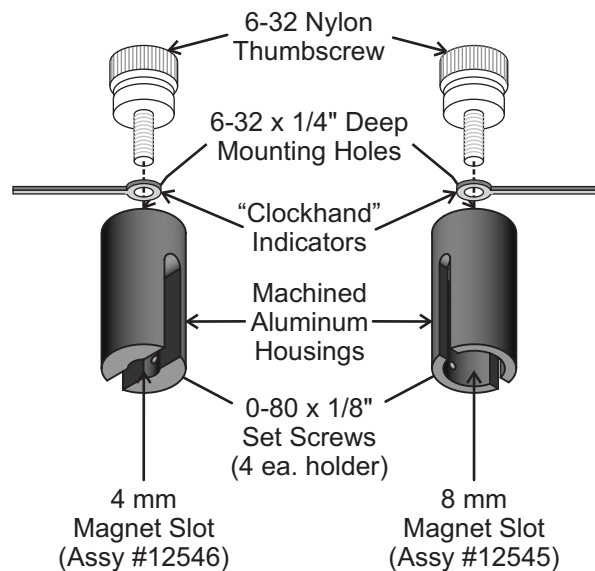

**Figure 14. 4 mm magnet holder (part #12546; left) and 8 mm magnet holder (part #12545; right).**  
0.44" dia. x 0.88" tall (11 mm x 22 mm) outside dimensions; actual size).

The holders are compatible with several popular diametrically-magnetized disk magnets and can be used in the AG956-07E Evaluation Kit:

Holder Part Number	Outside Dimensions	Compatible Magnets (NVE part #s)	Magnet Diameter (mm)	Max. Magnet Length (mm)
12546	11 mm dia. x 22 mm tall	12526	4	4
12545		12527; 12528	8	8

**Table 3. Magnet holders.**

**2.5 x 2.5 mm TDFN6 Package**

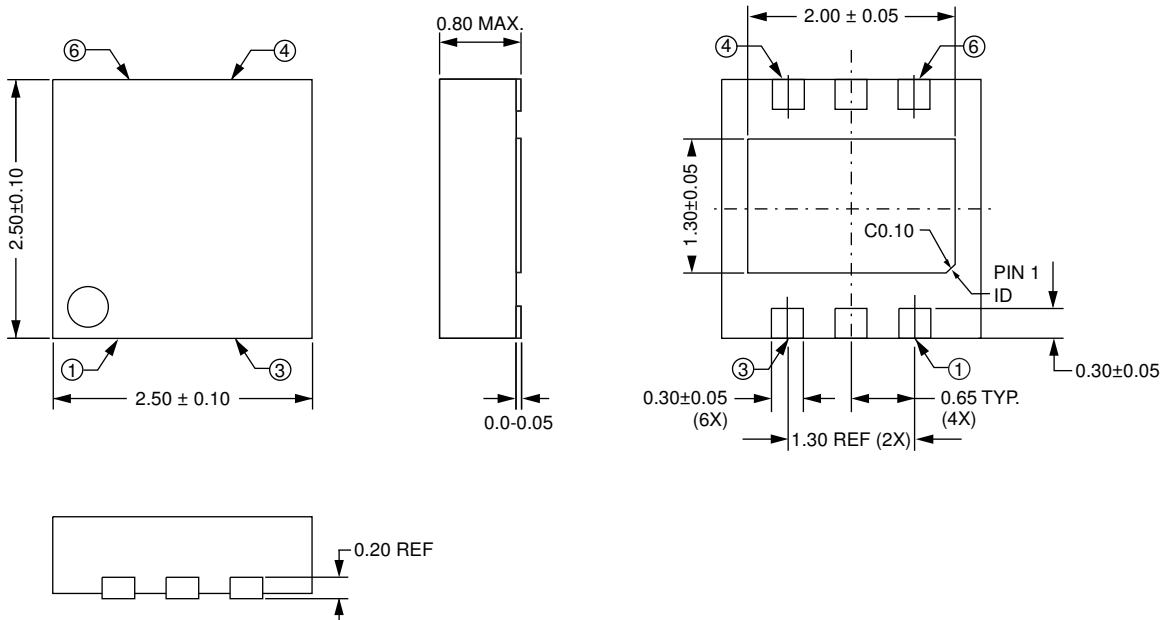

Pad	Symbol	Description
1	GND	Ground/ $V_{SS}$
2	SCLK	SPI Clock Input
3	MISO	Sensor SPI Data Output
4	VDD	Power Supply (bypass with a 10 $\mu$ F capacitor)
5	MOSI	Sensor SPI Data Input
6	SS	Sensor Select Input (low to select)
Center pad		Internal leadframe connection; connect to GND to minimize noise.

**Notes:**

- Dimensions in millimeters.
- Soldering profile per JEDEC J-STD-020C, MSL 1.



**Ordering Information**

# ASR002 - 10E TR13

**Product Family**

ASR = Smart Angle Sensors

**I/O**

00 = SPI

01 = I<sup>2</sup>C / PWM

01 = ABZ (Encoder)

**Sensor Element**

2 = High speed, medium accuracy

**Field Range Identifier**

Blank = General Purpose (6 to 20 mT / 60 to 200 Oe)

**Part Package**

10E = RoHS-Compliant 2.5 x 2.5 mm TDFN6 Package

**Bulk Packaging**

TR13 = 13" Tape and Reel Package

**Available Product Variants**

Part Number	Breakout Board	Evaluation Kit	Repeat-ability	Resolution	Speed	Outputs
ASR002-10E	AG956-07	AG956-07	0.2°	0.1°	12500 Sps	SPI
ASR012-10E	AG966-07	AG963-07		I <sup>2</sup> C; PWM		
ASR022-10E	AG967-07	AG964-07		512 virtual lines (128 cycles) / rev.		ABZ; Dir

## Revision History

<p><b>SB-00-081-K</b> September 2019</p>	<p><b>Changes</b></p> <ul style="list-style-type: none"> <li>• Recommend 10 <math>\mu</math>F bypass capacitor added specifics on p. 10.</li> <li>• Added bypass capacitor details to microcontroller application circuit. (p. 12).</li> <li>• Added second bypass capacitor to breakout board (p. 17).</li> </ul>
<p><b>SB-00-081-J</b> August 2019</p>	<p><b>Changes</b></p> <ul style="list-style-type: none"> <li>• Added Absolute Maximum output current specification (p. 2).</li> <li>• Offering a breakout board instead of a bare board (p. 17).</li> </ul>
<p><b>SB-00-081-I</b> July 2019</p>	<p><b>Changes</b></p> <ul style="list-style-type: none"> <li>• Clarified lot code formatting and corrected its memory address range (p. 9).</li> </ul>
<p><b>SB-00-081-H</b> June 2019</p>	<p><b>Changes</b></p> <ul style="list-style-type: none"> <li>• Noted 17.5 mT (175 Oe) factory calibration field (p. 4, Note 1).</li> <li>• Clarified two-byte and four-byte SPI read and write sequences (p. 8).</li> <li>• Corrected default filter memory setting (p. 9).</li> </ul>
<p><b>SB-00-081-G</b> June 2019</p>	<p><b>Changes</b></p> <ul style="list-style-type: none"> <li>• Added SI units (tesla) in addition to CGS (oersteds).</li> <li>• Changed Operating Specification “RAM Timing” from maximums to minimums.</li> </ul>
<p><b>SB-00-081-F</b> April 2019</p>	<p><b>Changes</b></p> <ul style="list-style-type: none"> <li>• Recommend 1 <math>\mu</math>F bypass capacitor.</li> </ul>
<p><b>SB-00-081-E</b> Feb. 2019</p>	<p><b>Changes</b></p> <ul style="list-style-type: none"> <li>• Improved “Magnet Selection” section.</li> <li>• Added magnet and magnet holder information (p. 18).</li> </ul>
<p><b>SB-00-081-D</b> Feb. 2019</p>	<p><b>Changes</b></p> <ul style="list-style-type: none"> <li>• Added details on center pad and grounding recommendation to minimize noise.</li> </ul>
<p><b>SB-00-081-C</b> Jan. 2019</p>	<p><b>Changes</b></p> <ul style="list-style-type: none"> <li>• Faster RAM timing.</li> <li>• Reduced data transfer rate from 2.5 to 2 Mbits/s for more design margin.</li> <li>• Corrected number of bits in angular offset.</li> <li>• Added Arduino code to zero the Sensor.</li> <li>• Added “In Case of Difficulty” section.</li> <li>• Dropped daisy-chained SPI application diagram (not supported).</li> <li>• Added AG954-07E socket board.</li> <li>• Typographic and cosmetic changes.</li> </ul>
<p><b>SB-00-081-B</b> Jan. 2019</p>	<p><b>Change</b></p> <ul style="list-style-type: none"> <li>• Added typical communications pseudocode.</li> </ul>
<p><b>SB-00-081-A</b> Jan. 2019</p>	<p><b>Changes</b></p> <ul style="list-style-type: none"> <li>• Expanded and updated SPI timing specifications.</li> <li>• Added detailed SPI timing diagrams.</li> <li>• Tightened typ. supply current specification to 4 mA.</li> <li>• Revised minimum operating field to 60 Oe.</li> <li>• Added sensor direction output and hysteresis parameter.</li> <li>• Added raw Sin and Cos vector outputs.</li> <li>• Added illustrative microcontroller code.</li> <li>• Finalized pinout.</li> <li>• Added evaluation kit and board.</li> <li>• Dropped customer calibration capability (unnecessary).</li> <li>• Various typographic corrections.</li> </ul>
<p><b>SB-00-081-PRELIM</b> Oct. 2018</p>	<p><b>Change</b></p> <ul style="list-style-type: none"> <li>• Preliminary release.</li> </ul>

### Datasheet Limitations

The information and data provided in datasheets shall define the specification of the product as agreed between NVE and its customer, unless NVE and customer have explicitly agreed otherwise in writing. All specifications are based on NVE test protocols. In no event however, shall an agreement be valid in which the NVE product is deemed to offer functions and qualities beyond those described in the datasheet.

### Limited Warranty and Liability

Information in this document is believed to be accurate and reliable. However, NVE does not give any representations or warranties, expressed or implied, as to the accuracy or completeness of such information and shall have no liability for the consequences of use of such information.

In no event shall NVE be liable for any indirect, incidental, punitive, special or consequential damages (including, without limitation, lost profits, lost savings, business interruption, costs related to the removal or replacement of any products or rework charges) whether or not such damages are based on tort (including negligence), warranty, breach of contract or any other legal theory.

### Right to Make Changes

NVE reserves the right to make changes to information published in this document including, without limitation, specifications and product descriptions at any time and without notice. This document supersedes and replaces all information supplied prior to its publication.

### Use in Life-Critical or Safety-Critical Applications

Unless NVE and a customer explicitly agree otherwise in writing, NVE products are not designed, authorized or warranted to be suitable for use in life support, life-critical or safety-critical devices or equipment. NVE accepts no liability for inclusion or use of NVE products in such applications and such inclusion or use is at the customer's own risk. Should the customer use NVE products for such application whether authorized by NVE or not, the customer shall indemnify and hold NVE harmless against all claims and damages.

### Applications

Applications described in this datasheet are illustrative only. NVE makes no representation or warranty that such applications will be suitable for the specified use without further testing or modification.

Customers are responsible for the design and operation of their applications and products using NVE products, and NVE accepts no liability for any assistance with applications or customer product design. It is customer's sole responsibility to determine whether the NVE product is suitable and fit for the customer's applications and products planned, as well as for the planned application and use of customer's third party customers. Customers should provide appropriate design and operating safeguards to minimize the risks associated with their applications and products.

NVE does not accept any liability related to any default, damage, costs or problem which is based on any weakness or default in the customer's applications or products, or the application or use by customer's third party customers. The customer is responsible for all necessary testing for the customer's applications and products using NVE products in order to avoid a default of the applications and the products or of the application or use by customer's third party customers. NVE accepts no liability in this respect.

### Limiting Values

Stress above one or more limiting values (as defined in the Absolute Maximum Ratings System of IEC 60134) will cause permanent damage to the device. Limiting values are stress ratings only and operation of the device at these or any other conditions above those given in the recommended operating conditions of the datasheet is not warranted. Constant or repeated exposure to limiting values will permanently and irreversibly affect the quality and reliability of the device.

### Terms and Conditions of Sale

In case an individual agreement is concluded only the terms and conditions of the respective agreement shall apply. NVE hereby expressly objects to applying the customer's general terms and conditions with regard to the purchase of NVE products by customer.

### No Offer to Sell or License

Nothing in this document may be interpreted or construed as an offer to sell products that is open for acceptance or the grant, conveyance or implication of any license under any copyrights, patents or other industrial or intellectual property rights.

### Export Control

This document as well as the items described herein may be subject to export control regulations. Export might require a prior authorization from national authorities.

### Automotive Qualified Products

Unless the datasheet expressly states that a specific NVE product is automotive qualified, the product is not suitable for automotive use. It is neither qualified nor tested in accordance with automotive testing or application requirements. NVE accepts no liability for inclusion or use of non-automotive qualified products in automotive equipment or applications.

In the event that customer uses the product for design-in and use in automotive applications to automotive specifications and standards, customer (a) shall use the product without NVE's warranty of the product for such automotive applications, use and specifications, and (b) whenever customer uses the product for automotive applications beyond NVE's specifications such use shall be solely at customer's own risk, and (c) customer fully indemnifies NVE for any liability, damages or failed product claims resulting from customer design and use of the product for automotive applications beyond NVE's standard warranty and NVE's product specifications.

An ISO 9001 Certified Company

NVE Corporation  
11409 Valley View Road  
Eden Prairie, MN 55344-3617 USA  
Telephone: (952) 829-9217  
[www.nve.com](http://www.nve.com)  
e-mail: [sensor-info@nve.com](mailto:sensor-info@nve.com)

©NVE Corporation

All rights are reserved. Reproduction in whole or in part is prohibited without the prior written consent of the copyright owner.

SB-00-081\_ASR002-10\_RevK

*January 2020*